

# INTEGRAL

1040UAP100R05-32 RAL9002

EAN 4031582455328

Swivel castor, solid plug fitting. Wheel centre made of Polyamide, Tread: Polyurethane, precision ball bearing



BETTER MOBILITY. BETTER LIFE.



Picture may differ from original product

## Technical Data

Wheel diameter	100 mm
Wheel width	32 mm
Castor width	62 mm
Bolt-Ø	32 mm
Bolt length	45 mm
Dome-Ø	62 mm
Offset	40 mm
Swivel Interference	180 mm
Overall height	130 mm
Temperature	- 25 / - 25 °C
Standard	EN 12531
Weight	0.978 kg
Swivel Radius	90 mm
Hardness of tread	Shore D 42
Load capacity	100 kg
Load capacity (static)	300 kg

## Dimensions

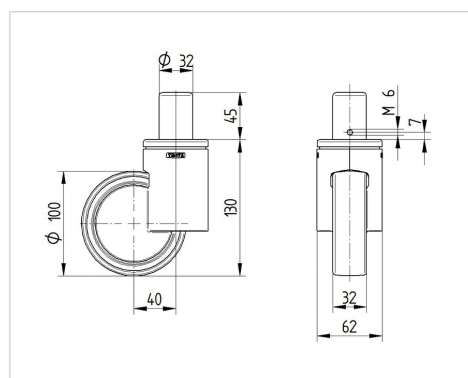

## Advantages at a glance

Roll performance	● ● ● ● ○
Movement noise	● ● ● ○ ○
Attrition	● ● ● ● ○
Corrosion resistance	● ● ● ○ ○