

INTEGRAL

1040UAX100R05-32 RAL7001

EAN 4031582455601

Swivel caster, solid plug fitting. Wheel center made of Polyamide, Tread: Polyurethane, with threadguards, precision ball bearing, sealed



BETTER MOBILITY. BETTER LIFE.



Picture may differ from original product

Technical Data

Wheel diameter	100 mm
Wheel width	32 mm
Caster width	62 mm
Bolt-Ø	32 mm
Bolt length	50 mm
Offset	40 mm
Swivel Interference	180 mm
Overall height	130 mm
Temperature	- 30 / + 80 °C
Standard	EN 12531 (load capacity)
Weight	0.984 kg
Swivel Radius	90 mm
Hardness of tread	Shore D 42
Load capacity (dynamic)	100 kg
Load capacity (static)	300 kg

Dimensions

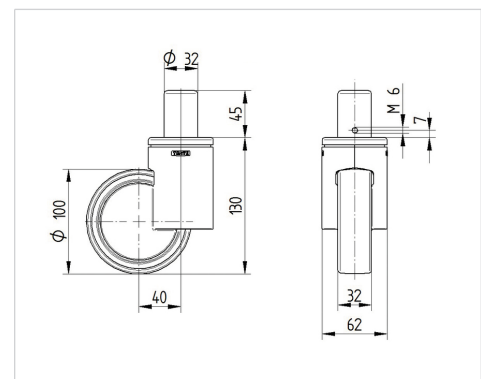

Advantages at a glance

Roll performance	● ● ● ● ○
Movement noise	● ● ● ○ ○
Attrition	● ● ● ● ○
Corrosion resistance	● ● ● ○ ○