

INTEGRAL

1044UAP100R36-32 S35 RAL9002

EAN 4031582455298

Swivel castor with central, total lock and central directional lock, stem with cam hole for profile bars, short version. Wheel centre made of Polyamide, Tread: Polyurethane, precision ball bearing



BETTER MOBILITY. BETTER LIFE.



Picture may differ from original product

Technical Data

Wheel diameter	100 mm
Wheel width	32 mm
Castor width	62 mm
Bolt-Ø	32 mm
Bolt length	51 mm
Offset	40 mm
Swivel Interference	180 mm
Overall height	130 mm
Temperature	- 30 / + 80 °C
Standard	EN 12531 (load capacity)
Weight	0.88 kg
Swivel Radius	90 mm
Hardness of tread	Shore D 42
Load capacity	100 kg
Load capacity (static)	300 kg

Dimensions

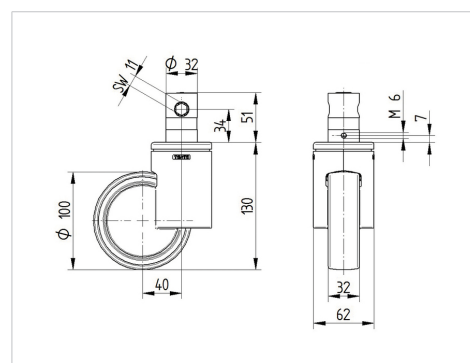

Advantages at a glance

Roll performance	● ● ● ● ○
Movement noise	● ● ● ○ ○
Attrition	● ● ● ● ○
Corrosion resistance	● ● ● ○ ○