

INTEGRAL

2040UAP150R05-32

EAN 4031582300130

Swivel castor, frame made of pressed steel, precision ball bearing in swivel head and wheel, housing cover made of synthetic plastics, solid plug fitting. Wheel centre made of Polyamide, Tread: Polyurethane, precision ball bearing



BETTER MOBILITY. BETTER LIFE.



Picture may differ from original product

Technical Data

Wheel diameter	150 mm
Wheel width	32 mm
Castor width	62 mm
Bolt-Ø	32 mm
Bolt length	45 mm
Dome-Ø	62 mm
Offset	40 mm
Swivel Interference	230 mm
Overall height	183 mm
Temperature	- 25 / - 25 °C
Standard	EN 12531
Weight	1.14 kg
Swivel Radius	115 mm
Hardness of tread	Shore D 42
Load capacity	150 kg
Load capacity (static)	450 kg

Advantages at a glance

Roll performance	● ● ● ○ ○
Movement noise	● ● ● ○ ○
Attrition	● ● ● ● ○
Corrosion resistance	● ● ● ○ ○

Dimensions

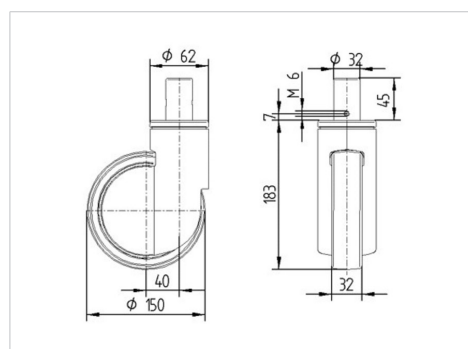

Structure & Mounting

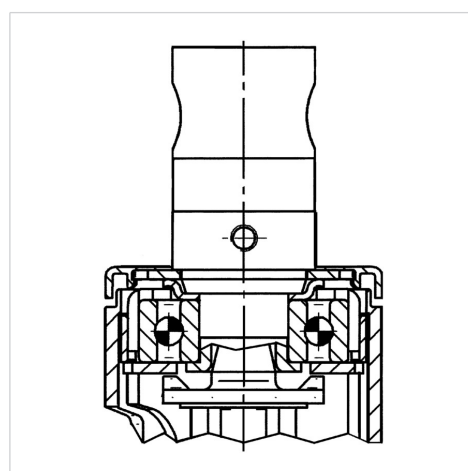

INTEGRAL

2040UAP150R05-32

EAN 4031582300130



BETTER MOBILITY. BETTER LIFE.

Structure & Mounting

