

AGILA

2478DIK100P50

EAN 4031582030228

Fiksirani točkić, Viljuska napravljena od presovanog celika, pocinkovana, Osovina tocka sa caurom, Priključak ploca..

Duza dimenzija ploce 90 van trake.

Telo tocka je napravljeno od presovanog celika. Omotac: cvrsta guma, siva - ne ostavlja trag, sa ratkapnama , konusni lezaj

TENTE

BETTER MOBILITY. BETTER LIFE.



Picture may differ from original product

Tehnicki podaci

Precnik tocka.	100 mm
Sirina gazista.	32 mm
Sirina tocka	60 mm
Dimenzije ploce.	77 x 67 mm
Raspored rupa na ploci.	61,5/56 x 51,5/46,5 mm
Rupa na ploci.	8,5 mm
Kupola -Ø	60 mm
Sveukupna visina.	135 mm
Temperatura	- 20 / + 85 °C
Standard	EN 12530
Tezina	0.781 kg
Tvrdoca omotaca	Shore A 80
Dinamicka nosivost.	80 kg
Staticka nosivost.	160 kg

Dimensions

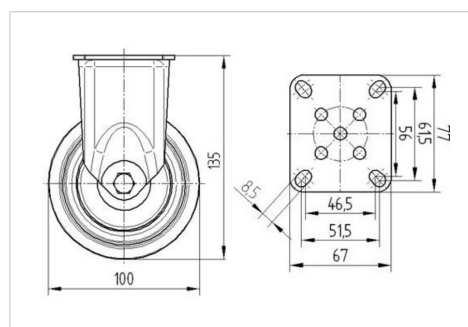

Advantages at a glance

Otpor okretanju	● ● ● ○ ○
Buka pri okretanju	● ● ● ○ ○
trenje , habanje	● ● ● ○ ○
zastita od korozije	● ● ● ○ ○

AGILA

2478DIK100P50

EAN 4031582030228



BETTER MOBILITY. BETTER LIFE.

Structure & Mounting

