

AGILA

2478PJO100P50

EAN 4031582030303

Fiksirani točkić, Viljuska napravljena od presovanog celika, pocinkovana, Osovina tocka sa caurom, Prikljucak ploca..

Duza dimenzija ploce 90 van trake.

Telo tocka od polipropilena , Omotac: TENTEprene (termoplasticna guma), siva - ne ostavlja trag , obican lezaj

TENTE

BETTER MOBILITY. BETTER LIFE.



Picture may differ from original product

Tehnicki podaci

Precnik tocka.	100 mm
Sirina gazista.	32 mm
Sirina tocka	60 mm
Dimenzije ploce.	77 x 67 mm
Raspored rupa na ploci.	61,5/56 x 51,5/46,5 mm
Rupa na ploci.	8,5 mm
Kupola -Ø	60 mm
Sveukupna visina.	135 mm
Temperatura	- 20 / + 60 °C
Standard	EN 12530
Tezina	0.477 kg
Tvrdoca omotaca	Shore A 87
Dinamicka nosivost.	80 kg
Staticka nosivost.	160 kg

Dimensions

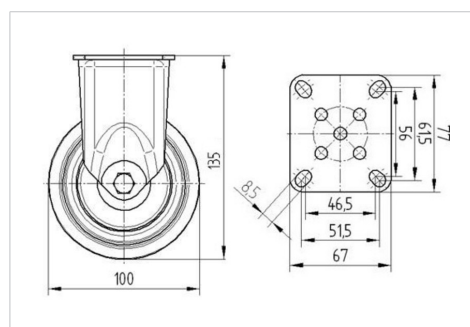

Advantages at a glance

Otpor okretanju	● ● ● ○ ○
Buka pri okretanju	● ● ● ○ ○
trenje , habanje	● ● ● ○ ○
zastita od korozije	● ● ● ○ ○

AGILA

2478PJO100P50

EAN 4031582030303



BETTER MOBILITY. BETTER LIFE.

Structure & Mounting

