

ALPHA

3470DVR200P63

EAN 4031582010275

Obrtni točkić, Kuciste napravljeno od presovanog celika, pocinkovano , dupli kuglični lezaj u okretnoj glavi, osovina tocka sa caurom, stitnik od prasine, Priklijućak ploca.. Telo tocka je napravljeno od presovanog celika. Omotac: cvrsta crna guma, valjkasti lezaj.

TENTE

BETTER MOBILITY. BETTER LIFE.



Picture may differ from original product

Tehnicki podaci

Precnik tocka.	200 mm
Sirina gazista.	50 mm
Sirina tocka	96 mm
Dimenzije ploce.	137 x 105 mm
Raspored rupa na ploci.	105 x 80/75 mm
Rupa na ploci.	11 mm
Kupola -Ø	96 mm
Dislokacija	55 mm
Otpor okretanju.	310 mm
Sveukupna visina.	240 mm
Temperatura	- 20 / + 85 °C
Standard	EN 12532
Tezina	2.613 kg
Radius okretanja	155 mm
Tvrdoca omotaca	Shore A 80
Dinamicka nosivost.	205 kg
Staticka nosivost.	410 kg

Advantages at a glance

Otpor okretanju	● ● ● ○ ○
Buka pri okretanju	● ● ● ○ ○
trenje , habanje	● ● ○ ○ ○
zastita od korozije	● ● ● ○ ○

Dimensions

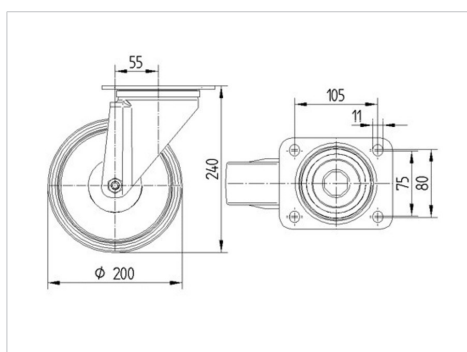

Structure & Mounting

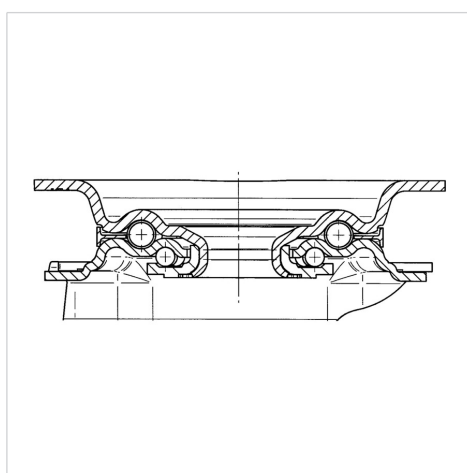

ALPHA

3470DVR200P63

EAN 4031582010275



BETTER MOBILITY. BETTER LIFE.

Structure & Mounting

