

# ALPHA

3470DVR200R05-20x45

EAN 4031582303636

Swivel castor, housing made of pressed steel, bright zinc plated, blue passivated, double ball bearing swivel head, wheel axle with nut, solid plug fitting. Wheel centre made of pressed steel, Tread: solid rubber, black, roller bearing



BETTER MOBILITY. BETTER LIFE.



Picture may differ from original product

## Technical Data

Wheel diameter	200 mm
Wheel width	50 mm
Bolt-Ø	20 mm
Bolt length	45 mm
Offset	55 mm
Swivel Interference	310 mm
Overall height	235 mm
Temperature	- 20 / + 60 °C
Standard	EN 12532
Weight	3.168 kg
Swivel Radius	155 mm
Hardness of tread	Shore A 85
Load capacity	205 kg
Load capacity (static)	410 kg

## Structure & Mounting

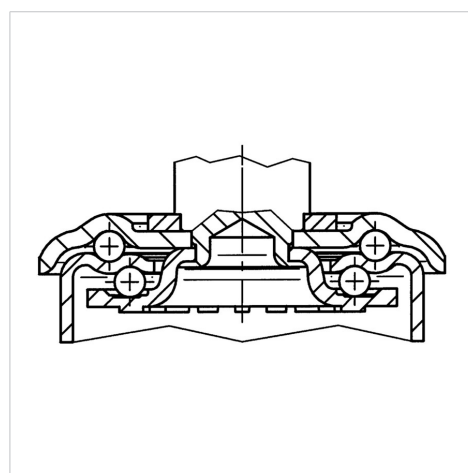

## Advantages at a glance

Roll performance	● ● ● ○ ○
Movement noise	● ● ● ○ ○
Attrition	● ● ○ ○ ○
Corrosion resistance	● ● ● ○ ○