

# ALPHA

## 3470UAR080P62 grey

EAN 4031582304251

Obrtni točkić, Kuciste napravljeno od presovanog celika, pocinkovano , dupli kuglični lezaj u okretnoj glavi, osovina tocka sa caurom, stitnik od prasine, Priklijućak ploca.. Telo tocka od poliamida, Omotac> Poliuretan, valjkasti lezaj

**TENTE**

BETTER MOBILITY. BETTER LIFE.



Picture may differ from original product

### Tehnicki podaci

Precnik tocka.	80 mm
Sirina gazista.	38 mm
Sirina tocka	75 mm
Dimenzije ploce.	105 x 80 mm
Raspored rupa na ploci.	80/77 x 60 mm
Rupa na ploci.	9 mm
Kupola -Ø	75 mm
Dislokacija	40 mm
Otpor okretanju.	160 mm
Sveukupna visina.	108 mm
Temperatura	- 25 / + 80 °C
Standard	EN 12532
Tezina	0.721 kg
Radius okretanja	80 mm
Tvrdoca omotaca	Shore D 42
Dinamicka nosivost.	150 kg
Staticka nosivost.	300 kg

### Advantages at a glance

Otpor okretanju	● ● ● ○ ○
Buka pri okretanju	● ● ● ○ ○
trenje , habanje	● ● ● ● ○
zastita od korozije	● ● ● ○ ○

### Dimensions

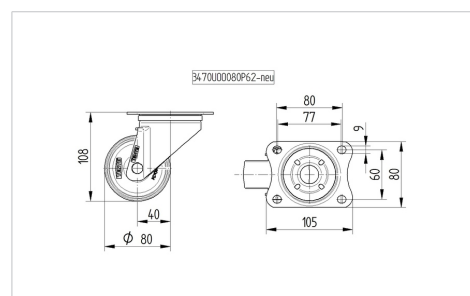

### Structure & Mounting

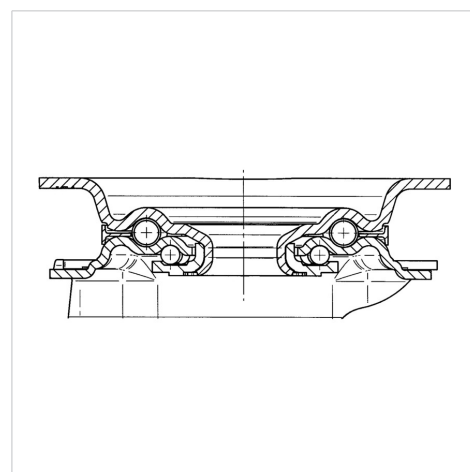

# ALPHA

3470UAR080P62 grey

EAN 4031582304251



BETTER MOBILITY. BETTER LIFE.

## Structure & Mounting

---

