

ALPHA

3470UAR100P62 grey

EAN 4031582304268

Swivel castor, housing made of pressed steel, bright zinc plated, blue passivated, double ball bearing swivel head, wheel axle with nut, dustguard, plate fitting. Wheel centre made of Polyamide, Tread: Polyurethane, roller bearing



BETTER MOBILITY. BETTER LIFE.



Picture may differ from original product

Technical Data

Wheel diameter	100 mm
Wheel width	32 mm
Castor width	75 mm
Size of Plate	105 x 80 mm
Plate hole centres	80/77 x 60 mm
Plate hole	9 mm
Dome-Ø	75 mm
Offset	40 mm
Swivel Interference	180 mm
Overall height	128 mm
Temperature	- 25 / + 80 °C
Standard	EN 12532
Weight	0.805 kg
Swivel Radius	90 mm
Hardness of tread	Shore D 42
Load capacity	150 kg
Load capacity (static)	300 kg

Dimensions

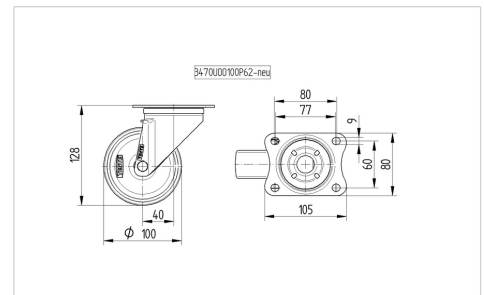

Structure & Mounting

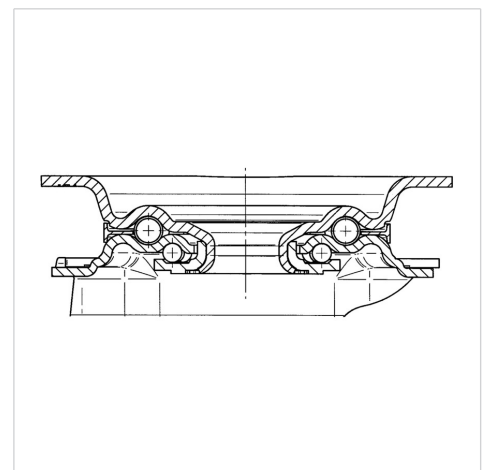

Advantages at a glance

Roll performance	● ● ● ○ ○
Movement noise	● ● ● ○ ○
Attrition	● ● ● ● ○
Corrosion resistance	● ● ● ○ ○

ALPHA

3470UAR100P62 grey

EAN 4031582304268



BETTER MOBILITY. BETTER LIFE.

Structure & Mounting

