

ALPHA

3470UAR200P63 red

EAN 4031582304305

Obrtni točkić, Kuciste napravljeno od presovanog celika, pocinkovano , dupli kuglični lezaj u okretnoj glavi, osovina tocka sa caurom, stitnik od prasine, Priklijućak ploca.. Telo tocka od poliamida, Omotac> Poliuretan, valjkasti lezaj

TENTE

BETTER MOBILITY. BETTER LIFE.



Picture may differ from original product

Tehnicki podaci

Precnik tocka.	200 mm
Sirina gazista.	46 mm
Sirina tocka	96 mm
Dimenzije ploce.	137 x 105 mm
Raspored rupa na ploci.	105 x 80/75 mm
Rupa na ploci.	11 mm
Kupola -Ø	96 mm
Dislokacija	55 mm
Otpor okretanju.	310 mm
Sveukupna visina.	240 mm
Temperatura	- 25 / + 80 °C
Standard	EN 12532
Tezina	2.368 kg
Radius okretanja	155 mm
Tvrdoca omotaca	Shore D 42
Dinamicka nosivost.	350 kg
Staticka nosivost.	700 kg

Advantages at a glance

Otpor okretanju	● ● ● ○ ○
Buka pri okretanju	● ● ● ○ ○
trenje , habanje	● ● ● ● ○
zastita od korozije	● ● ● ○ ○

Dimensions

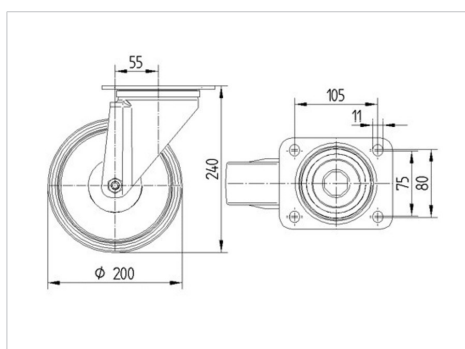

Structure & Mounting

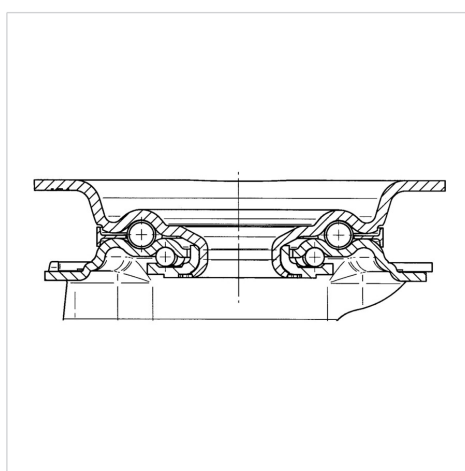

ALPHA

3470UAR200P63 red

EAN 4031582304305



BETTER MOBILITY. BETTER LIFE.

Structure & Mounting

