

ALPHA

3477DIR200P63

EAN 4031582305104

Swivel caster with total lock, trailing end of caster, housing made of pressed steel, bright zinc plated, blue passivated, double ball bearing swivel head, wheel axle with nut, dustguard, plate fitting. Wheel center made of pressed steel, Tread: solid rubber, grey non-marking, roller bearing



BETTER MOBILITY. BETTER LIFE.



Picture may differ from original product

Technical Data

Wheel diameter	200 mm
Wheel width	50 mm
Caster width	96 mm
Plate size	137 x 105 mm
Plate hole centers	105 x 80/75 mm
Plate hole	11 mm
Dome-Ø	96 mm
Offset	55 mm
Swivel Interference	334 mm
Overall height	240 mm
Temperature	- 20 / + 85 °C
Standard	EN 12532
Weight	3.579 kg
Swivel Radius	167 mm
Hardness of tread	Shore A 80
Load capacity (dynamic)	205 kg
Load capacity (static)	410 kg

Dimensions

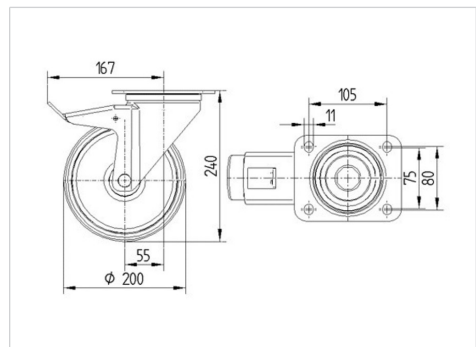

Structure & Mounting

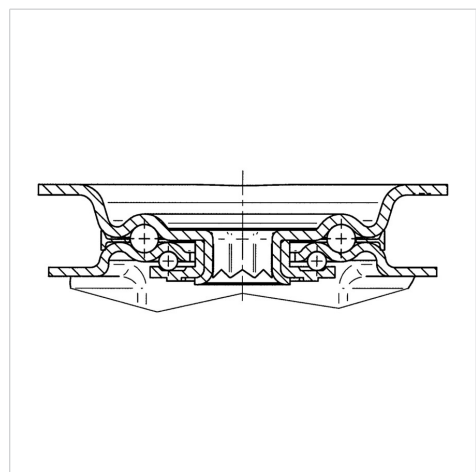

Advantages at a glance

Roll performance	● ● ● ○ ○
Movement noise	● ● ● ○ ○
Attrition	● ● ● ○ ○
Corrosion resistance	● ● ● ○ ○

ALPHA

3477DIR200P63

EAN 4031582305104



BETTER MOBILITY. BETTER LIFE.

Structure & Mounting

