

ALPHA

3477PVR100P62

EAN 4031582050714

Swivel caster with total lock, trailing end of caster, housing made of pressed steel, bright zinc plated, blue passivated, double ball bearing swivel head, wheel axle with nut, dustguard, plate fitting. Wheel center made of Polypropylene, Tread: solid rubber, black, roller bearing



BETTER MOBILITY. BETTER LIFE.



Picture may differ from original product

Technical Data

Wheel diameter	100 mm
Wheel width	35 mm
Caster width	75 mm
Plate size	105 x 80 mm
Plate hole centers	80/77 x 60 mm
Plate hole	9 mm
Dome-Ø	75 mm
Offset	41 mm
Swivel Interference	246 mm
Overall height	128 mm
Temperature	- 20 / + 60 °C
Standard	EN 12532
Weight	0.959 kg
Swivel Radius	123 mm
Hardness of tread	Shore A 80
Load capacity (dynamic)	75 kg
Load capacity (static)	150 kg

Dimensions

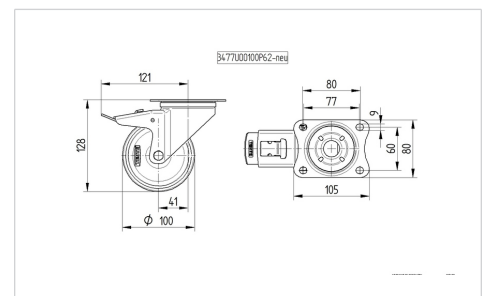

Structure & Mounting

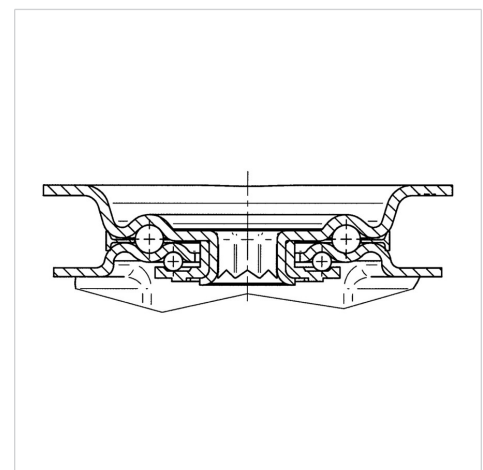

Advantages at a glance

Roll performance	● ● ● ○ ○
Movement noise	● ● ● ○ ○
Attrition	● ● ○ ○ ○
Corrosion resistance	● ● ● ○ ○

ALPHA

3477PVR100P62

EAN 4031582050714



BETTER MOBILITY. BETTER LIFE.

Structure & Mounting

