

ALPHA

3477PVR200P63

EAN 4031582050745

Swivel castor with total lock, tail end of castor, housing made of pressed steel, bright zinc plated, blue passivated, double ball bearing swivel head, wheel axle with nut, dustguard, plate fitting. Wheel centre made of Polypropylene, Tread: solid rubber, black, roller bearing



BETTER MOBILITY. BETTER LIFE.



Picture may differ from original product

Technical Data

Wheel diameter	200 mm
Wheel width	50 mm
Castor width	96 mm
Size of Plate	137 x 105 mm
Plate hole centres	105 x 80/75 mm
Plate hole	11 mm
Dome-Ø	96 mm
Offset	55 mm
Swivel Interference	334 mm
Overall height	240 mm
Temperature	- 20 / + 60 °C
Standard	EN 12532
Weight	3.124 kg
Swivel Radius	167 mm
Hardness of tread	Shore A 80
Load capacity	205 kg
Load capacity (static)	410 kg

Advantages at a glance

Roll performance	● ● ● ○ ○
Movement noise	● ● ● ○ ○
Attrition	● ● ○ ○ ○
Corrosion resistance	● ● ● ○ ○

Dimensions

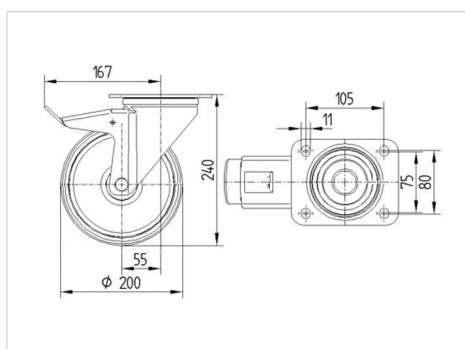

Structure & Mounting



ALPHA

3477PVR200P63

EAN 4031582050745



BETTER MOBILITY. BETTER LIFE.

Structure & Mounting

