

# ALPHA

## 3477UAR160P63 red

EAN 4031582305784

Okretni tocak sa potpunom kocnicom , zadnji deo tocka, Kuciste napravljeno od presovanog celika, pocinkovano , dupli kuglicni lezaj u okretnoj glavi, osovina tocka sa caurom, stitnik od prasine, Prikljucak ploca.. Telo tocka od poliamida, Omotac> Poliuretan, valjkasti lezaj

**TENTE**

BETTER MOBILITY. BETTER LIFE.



Picture may differ from original product

### Tehnicki podaci

Precnik tocka.	160 mm
Sirina gazista.	40 mm
Sirina tocka	96 mm
Dimenzije ploce.	137 x 105 mm
Raspored rupa na ploci.	105 x 80/75 mm
Rupa na ploci.	11 mm
Kupola -Ø	96 mm
Dislokacija	60 mm
Otpor okretanju.	334 mm
Sveukupna visina.	200 mm
Temperatura	- 25 / + 80 °C
Standard	EN 12532
Tezina	2.27 kg
Radius okretanja	167 mm
Tvrdoca omotaca	Shore D 42
Dinamicka nosivost.	350 kg
Staticka nosivost.	700 kg

### Advantages at a glance

Otpor okretanju	● ● ● ○ ○
Buka pri okretanju	● ● ● ○ ○
trenje , habanje	● ● ● ● ○
zastita od korozije	● ● ● ○ ○

### Dimensions

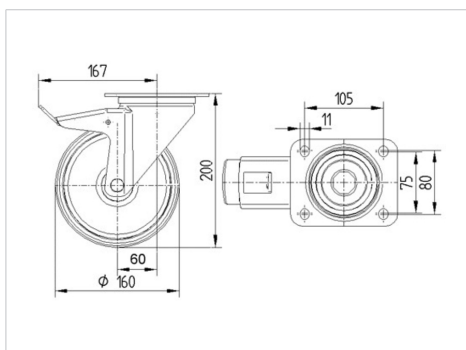

### Structure & Mounting

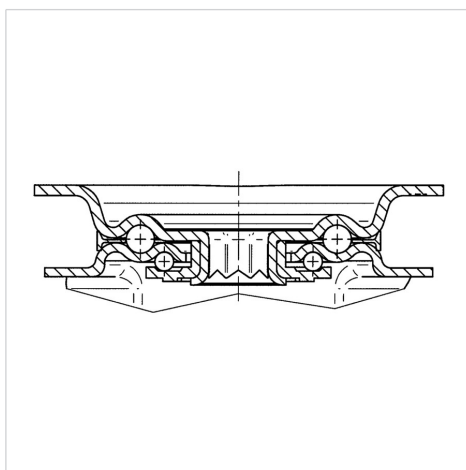

# ALPHA

3477UAR160P63 red

EAN 4031582305784



BETTER MOBILITY. BETTER LIFE.

## Structure & Mounting

