

ALPHA

3477UER200P63

EAN 4031582305869

Okretni tocak sa potpunom kocnicom , zadnji deo tocka, Kuciste napravljeno od presovanog celika, pocinkovano , dupli kuglicni lezaj u okretnoj glavi, osovina tocka sa caurom, stitnik od prasine, Prikljucak ploca.. Telo tocka od poliamida, Omotac: elasticka guma , crna , valjkasti lezaj

TENTE

BETTER MOBILITY. BETTER LIFE.



Picture may differ from original product

Tehnicki podaci

Precnik tocka.	200 mm
Sirina gazista.	46 mm
Sirina tocka	96 mm
Dimenzije ploce.	137 x 105 mm
Raspored rupa na ploci.	105 x 80/75 mm
Rupa na ploci.	11 mm
Kupola -Ø	96 mm
Dislokacija	55 mm
Otpor okretanju.	334 mm
Sveukupna visina.	240 mm
Temperatura	- 20 / + 80 °C
Standard	EN 12532
Tezina	2.886 kg
Radius okretanja	167 mm
Tvrdoca omotaca	Shore A 63
Dinamicka nosivost.	400 kg
Staticka nosivost.	800 kg

Advantages at a glance

Otpor okretanju	● ● ● ○ ○
Buka pri okretanju	● ● ● ● ●
trenje , habanje	● ● ● ○ ○
zastita od korozije	● ● ● ○ ○

Dimensions

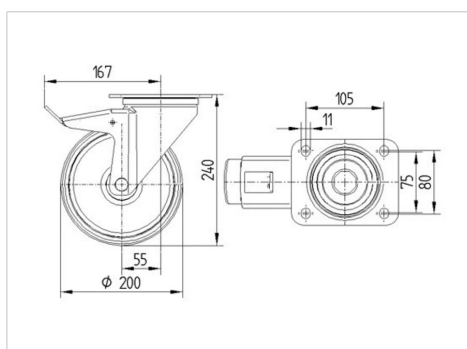

Structure & Mounting



ALPHA

3477UER200P63

EAN 4031582305869



BETTER MOBILITY. BETTER LIFE.

Structure & Mounting

