

ALPHA

3478DVR125P62

EAN 4031582030167

Fixed caster, Fork made of pressed steel, bright zinc plated, blue passivated, wheel axle with nut, plate fitting.
Wheel center made of pressed steel, Tread: solid rubber, black, roller bearing



BETTER MOBILITY. BETTER LIFE.



Picture may differ from original product

Technical Data

Wheel diameter	125 mm
Wheel width	37 mm
Caster width	85 mm
Plate size	103 x 85 mm
Plate hole centers	80/77 x 60 mm
Plate hole	9 mm
Overall height	155 mm
Temperature	- 20 / + 85 °C
Standard	EN 12532
Weight	0.934 kg
Hardness of tread	Shore A 80
Load capacity (dynamic)	100 kg
Load capacity (static)	200 kg

Dimensions

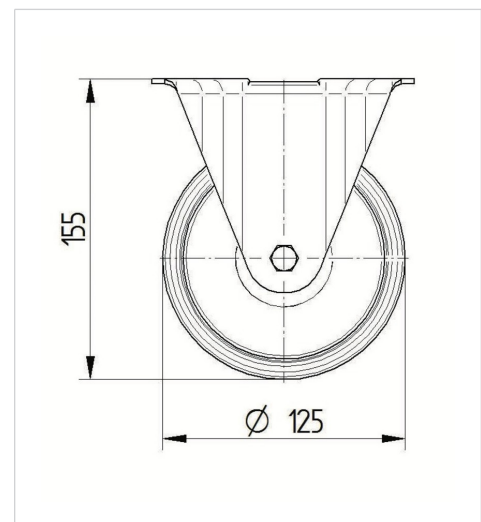

Advantages at a glance

Roll performance	● ● ● ○ ○
Movement noise	● ● ● ○ ○
Attrition	● ● ○ ○ ○
Corrosion resistance	● ● ● ○ ○

ALPHA

3478DVR125P62

EAN 4031582030167



BETTER MOBILITY. BETTER LIFE.

Structure & Mounting

