

ALPHA

3478DVR200P63

EAN 4031582030181

Fixed caster, Fork made of pressed steel, bright zinc plated, blue passivated, wheel axle with nut, plate fitting.
Wheel center made of pressed steel, Tread: solid rubber, black, roller bearing



BETTER MOBILITY. BETTER LIFE.



Picture may differ from original product

Technical Data

Wheel diameter	200 mm
Wheel width	50 mm
Caster width	115 mm
Plate size	140 x 115 mm
Plate hole centers	105 x 80/75 mm
Plate hole	11 mm
Overall height	240 mm
Temperature	- 20 / + 85 °C
Standard	EN 12532
Weight	2.125 kg
Hardness of tread	Shore A 80
Load capacity (dynamic)	205 kg
Load capacity (static)	410 kg

Dimensions

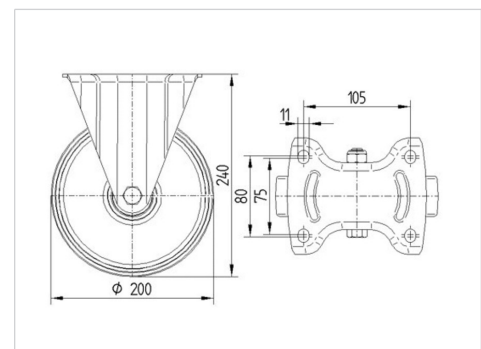

Advantages at a glance

Roll performance	● ● ● ○ ○
Movement noise	● ● ● ○ ○
Attrition	● ● ○ ○ ○
Corrosion resistance	● ● ● ○ ○

ALPHA

3478DVR200P63

EAN 4031582030181



BETTER MOBILITY. BETTER LIFE.

Structure & Mounting

