

ALPHA

3478ITP100P63

EAN 4031582030709

Fixed caster, Fork made of pressed steel, bright zinc plated, blue passivated, wheel axle with nut, plate fitting.
Wheel center made of Aluminum, Tread: Polyurethane, casted, precision ball bearing



BETTER MOBILITY. BETTER LIFE.



Picture may differ from original product

Technical Data

Wheel diameter	100 mm
Wheel width	40 mm
Caster width	115 mm
Plate size	136 x 117 mm
Plate hole centers	105 x 80/75 mm
Plate hole	11 mm
Overall height	125 mm
Temperature	- 10 / + 60 °C
Standard	EN 12532
Weight	0.981 kg
Hardness of tread	Shore D 42
Load capacity (dynamic)	300 kg
Load capacity (static)	600 kg

Dimensions

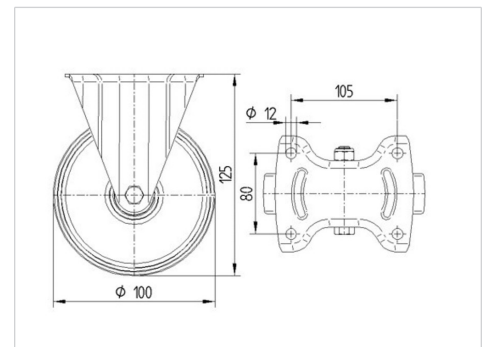

Advantages at a glance

Roll performance	● ● ● ○ ○
Movement noise	● ● ● ○ ○
Attrition	● ● ● ○ ○
Corrosion resistance	● ● ● ○ ○

ALPHA

3478ITP100P63

EAN 4031582030709



BETTER MOBILITY. BETTER LIFE.

Structure & Mounting

