

ALPHA

3478POR125P62 RAL9011

EAN 4031582306675

Faste hjul, Gaffel fremstillet af presset stål, forzinket, blåpassiveret, hjulaksel med møtrik, befæstigelsesplade.

Hjulfælg: Polypropylen, rulleleje



BETTER MOBILITY. BETTER LIFE.



Illustrationen kan afvige fra originalen

Tekniske data

Hjul-Ø	125 mm
Hjulbredde	40 mm
Hjulbredde	85 mm
Plademål	103 x 85 mm
Hulafstand	80/77 x 60 mm
Pladehul-Ø	9 mm
Byggehøjde	155 mm
Temperaturinterval	- 20 / + 60 °C
Standard	EN 12532
Vægt	0.57 kg
Hjulbane hårdhed	Shore D 65
Belastning (dynamisk)	200 kg
Belastning (statisk)	400 kg

Dimensioner

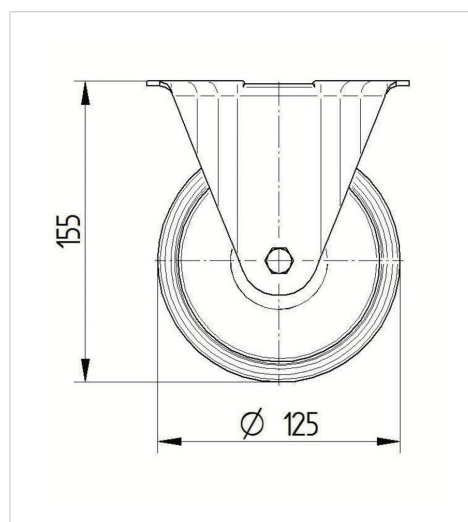

Egenskaber/fordele

Rullemodstand	● ● ● ○ ○
Kørselsstøj	● ● ● ○ ○
Slid	● ● ● ● ●
Rustbeskyttelse	● ● ● ○ ○

ALPHA

3478POR125P62 RAL9011

EAN 4031582306675



BETTER MOBILITY. BETTER LIFE.

Struktur og montering

