

ALPHA

3478POR125P62 RAL9011

EAN 4031582306675

Fixed castor, Fork made of pressed steel, bright zinc plated, blue passivated, wheel axle with nut, plate fitting.

Wheel centre made Polypropylene, roller bearing



BETTER MOBILITY. BETTER LIFE.



Picture may differ from original product

Technical Data

Wheel diameter	125 mm
Wheel width	40 mm
Castor width	85 mm
Size of Plate	103 x 85 mm
Plate hole centres	80/77 x 60 mm
Plate hole	9 mm
Overall height	155 mm
Temperature	- 20 / + 60 °C
Standard	EN 12532
Weight	0.57 kg
Hardness of tread	Shore D 65
Load capacity	200 kg
Load capacity (static)	400 kg

Dimensions

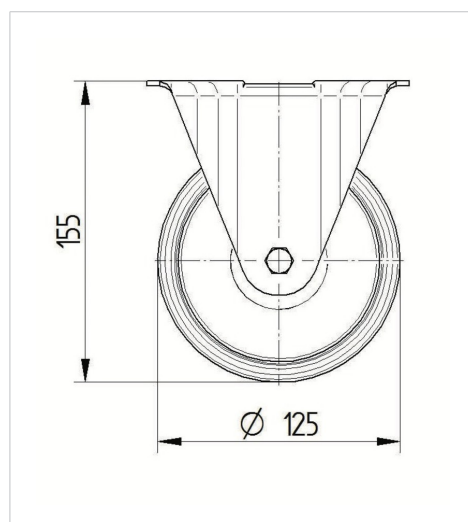

Advantages at a glance

Roll performance	● ● ● ○ ○
Movement noise	● ● ● ○ ○
Attrition	● ● ● ● ●
Corrosion resistance	● ● ● ○ ○

ALPHA

3478POR125P62 RAL9011

EAN 4031582306675



BETTER MOBILITY. BETTER LIFE.

Structure & Mounting

