

ALPHA

3478PVO200P63

EAN 4031582306767

Fixed castor, Fork made of pressed steel, bright zinc plated, blue passivated, wheel axle with nut, plate fitting.
Wheel centre made of Polypropylene, Tread: solid rubber, black, plain bearing



BETTER MOBILITY. BETTER LIFE.



Picture may differ from original product

Technical Data

Wheel diameter	200 mm
Wheel width	50 mm
Castor width	115 mm
Size of Plate	140 x 115 mm
Plate hole centres	105 x 80/75 mm
Plate hole	11 mm
Overall height	240 mm
Temperature	- 20 / + 60 °C
Standard	EN 12532
Weight	2.22 kg
Hardness of tread	Shore A 80
Load capacity	205 kg
Load capacity (static)	410 kg

Dimensions

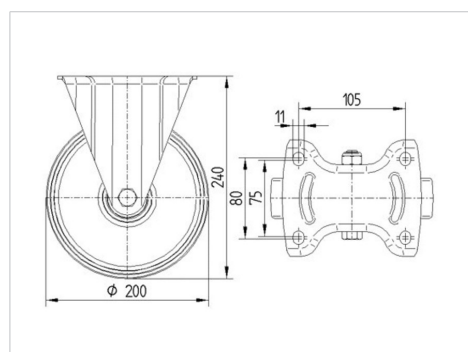

Advantages at a glance

Roll performance	● ● ○ ○ ○
Movement noise	● ● ● ○ ○
Attrition	● ● ○ ○ ○
Corrosion resistance	● ● ● ○ ○

ALPHA

3478PVO200P63

EAN 4031582306767



BETTER MOBILITY. BETTER LIFE.

Structure & Mounting

