

ALPHA

3478UER125P62

EAN 4031582306880

Fixed caster, Fork made of pressed steel, bright zinc plated, blue passivated, wheel axle with nut, plate fitting.
Wheel center made of Polyamide, Tread: elastic-tire, black, roller bearing



BETTER MOBILITY. BETTER LIFE.



Picture may differ from original product

Technical Data

Wheel diameter	125 mm
Wheel width	40 mm
Caster width	85 mm
Plate size	103 x 85 mm
Plate hole centers	80/77 x 60 mm
Plate hole	9 mm
Overall height	155 mm
Temperature	- 20 / + 80 °C
Standard	EN 12532
Weight	0.773 kg
Hardness of tread	Shore A 63
Load capacity (dynamic)	250 kg
Load capacity (static)	500 kg

Dimensions

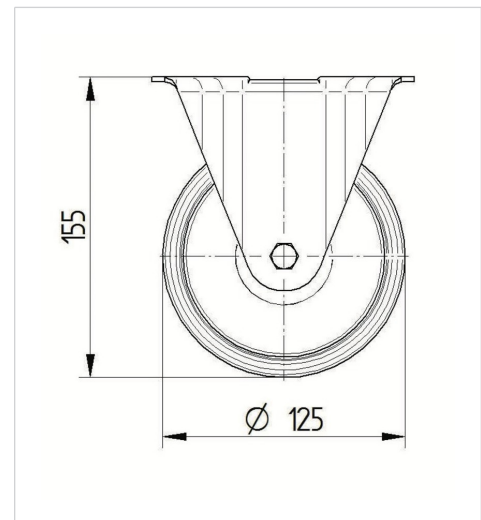

Advantages at a glance

Roll performance	● ● ● ○ ○
Movement noise	● ● ● ● ●
Attrition	● ● ● ○ ○
Corrosion resistance	● ● ● ○ ○

ALPHA

3478UER125P62

EAN 4031582306880



BETTER MOBILITY. BETTER LIFE.

Structure & Mounting

