

ZETA

4680IEP200P63

EAN 4031582307818

Swivel caster, housing made of very heavy pressed steel, reinforced, bright zinc plated, blue passivated, sealed swivel double ball bearing, reinforced and heat-treated ball covers, riveted king pin, wheel axle with nut and dust ring with integrated grease nipple., plate fitting. Wheel center made of Aluminum, Tread: black elastic-tire, vulcanized, precision ball bearing



BETTER MOBILITY. BETTER LIFE.



Picture may differ from original product

Technical Data

Wheel diameter	200 mm
Wheel width	50 mm
Caster width	96 mm
Plate size	137 x 105 mm
Plate hole centers	105 x 80/75 mm
Plate hole	11 mm
Dome-Ø	96 mm
Offset	55 mm
Swivel Interference	310 mm
Overall height	240 mm
Temperature	- 20 / + 85 °C
Standard	EN 12532
Weight	3.887 kg
Swivel Radius	155 mm
Hardness of tread	Shore A 67
Load capacity (dynamic)	450 kg
Load capacity (static)	900 kg

Dimensions

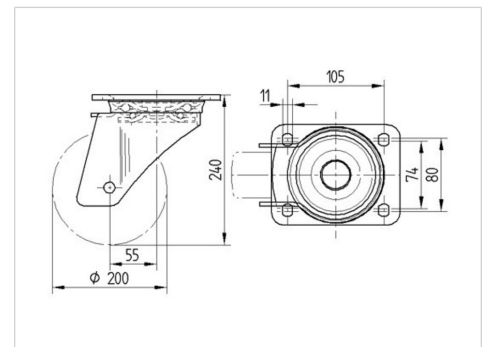

Structure & Mounting

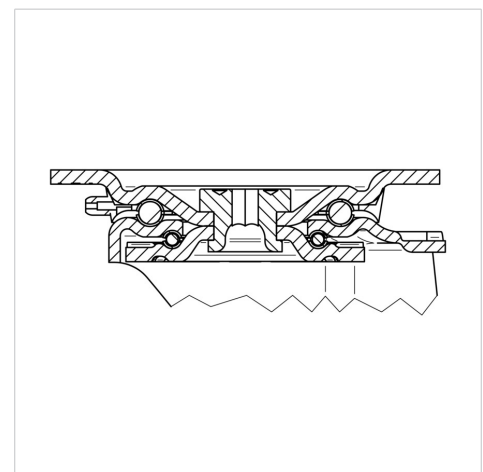

Advantages at a glance

Roll performance	● ● ● ○ ○
Movement noise	● ● ● ○ ○
Attrition	● ● ● ○ ○
Corrosion resistance	● ● ● ○ ○

ZETA

4680IEP200P63

EAN 4031582307818



BETTER MOBILITY. BETTER LIFE.

Structure & Mounting

