

# ZETA

## 4680IEP250P63

EAN 4031582307825

Obrtni točkić, Kuciste napravljeno od izuzetno jako presovanog celika , ojacanog , plavo cinkovanog , zasticeni dupli kuglicni lezajavi u glavcini, ojacani i termicki obradjeni pokrivaci kuglica, ploca nitovana , stitnik od prasine sa otvorom za podmazivanje, osovina tocka sa caurom., Prikljucak ploca.. Telo tocka od aluminijuma , Omotac: crna elasticna guma, vulkanizirana , precizni kuglicni lezaj

# TENTE

BETTER MOBILITY. BETTER LIFE.



Picture may differ from original product

### Tehnicki podaci

Precnik tocka.	250 mm
Sirina gazista.	50 mm
Sirina tocka	96 mm
Dimenzije ploce.	137 x 105 mm
Raspored rupa na ploci.	105 x 80/75 mm
Rupa na ploci.	11 mm
Kupola -Ø	96 mm
Dislokacija	55 mm
Otpor okretanju.	360 mm
Sveukupna visina.	290 mm
Temperatura	- 20 / + 85 °C
Standard	EN 12532
Tezina	4.579 kg
Radius okretanja	180 mm
Tvrdoca omotaca	Shore A 67
Dinamicka nosivost.	500 kg
Staticka nosivost.	1000 kg

### Advantages at a glance

Otpor okretanju	● ● ● ○ ○
Buka pri okretanju	● ● ● ○ ○
trenje , habanje	● ● ● ○ ○
zastita od korozije	● ● ● ○ ○

### Dimensions

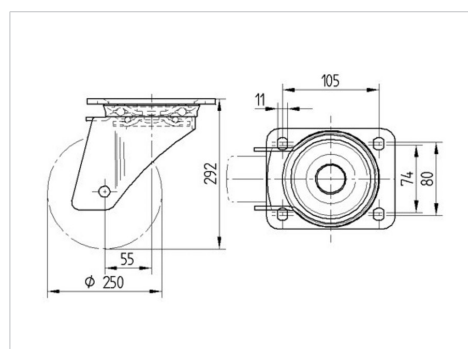

### Structure & Mounting



# ZETA

4680IEP250P63

EAN 4031582307825



BETTER MOBILITY. BETTER LIFE.

## Structure & Mounting

