

# ZETA

## 4680UOP200P63

EAN 4031582307917

Swivel caster, housing made of very heavy pressed steel, reinforced, bright zinc plated, blue passivated, sealed swivel double ball bearing, reinforced and heat-treated ball covers, riveted king pin, wheel axle with nut and dust ring with integrated grease nipple., plate fitting. Wheel center made of Polyamide, precision ball bearing



BETTER MOBILITY. BETTER LIFE.



Picture may differ from original product

### Technical Data

Wheel diameter	200 mm
Wheel width	50 mm
Caster width	96 mm
Plate size	137 x 105 mm
Plate hole centers	105 x 80/75 mm
Plate hole	11 mm
Dome-Ø	96 mm
Offset	55 mm
Swivel Interference	310 mm
Overall height	240 mm
Temperature	- 30 / + 80 °C
Standard	EN 12532
Weight	3.18 kg
Swivel Radius	155 mm
Hardness of tread	Shore D 75
Load capacity (dynamic)	800 kg
Load capacity (static)	1600 kg

### Dimensions

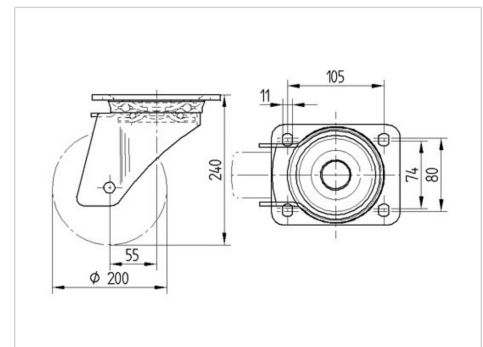

### Structure & Mounting

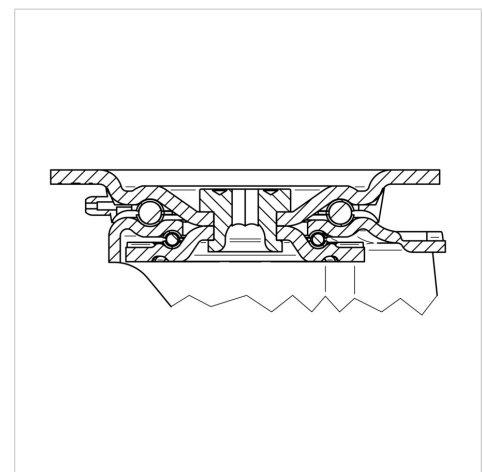

### Advantages at a glance

Roll performance	● ● ● ● ●
Movement noise	● ○ ○ ○ ○
Attrition	● ● ● ● ●
Corrosion resistance	● ● ● ○ ○

# ZETA

4680UOP200P63

EAN 4031582307917



BETTER MOBILITY. BETTER LIFE.

## Structure & Mounting

