

ZETA

4681ITP160P63 Flat

EAN 4031582307986

okretan tocak sa usmerenom kocnicom, Kuciste napravljeno od izuzetno jako presovanog celika , ojacanog , plavo cinkovanog , zasticeni dupli kuglicni lezajavi u glavcini, ojacani i termicki obradjeni pokrivaci kuglica, ploca nitovana , stitnik od prasine sa otvorom za podmazivanje, osovina tocka sa caurom., Prikljucak ploca.. Telo tocka od aluminijuma, Omotac: Poliuretan , liven, precizni kuglicni lezaj

TENTE

BETTER MOBILITY. BETTER LIFE.



Picture may differ from original product

Tehnicki podaci

Precnik tocka.	160 mm
Sirina gazista.	50 mm
Sirina tocka	96 mm
Dimenzije ploce.	137 x 105 mm
Raspored rupa na ploci.	105 x 80/75 mm
Rupa na ploci.	11 mm
Kupola -Ø	96 mm
Dislokacija	55 mm
Otpor okretanju.	270 mm
Sveukupna visina.	200 mm
Temperatura	- 10 / + 60 °C
Standard	EN 12532
Tezina	3.25 kg
Radius okretanja	135 mm
Tvrdoca omotaca	Shore D 42
Dinamicka nosivost.	800 kg
Staticka nosivost.	1600 kg

Advantages at a glance

Otpor okretanju	● ● ● ○ ○
Buka pri okretanju	● ● ● ○ ○
trenje , habanje	● ● ● ● ○
zastita od korozije	● ● ● ○ ○

Dimensions

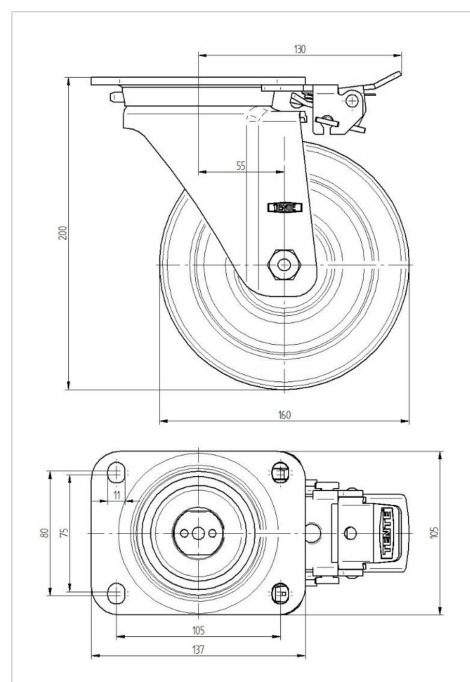

Structure & Mounting

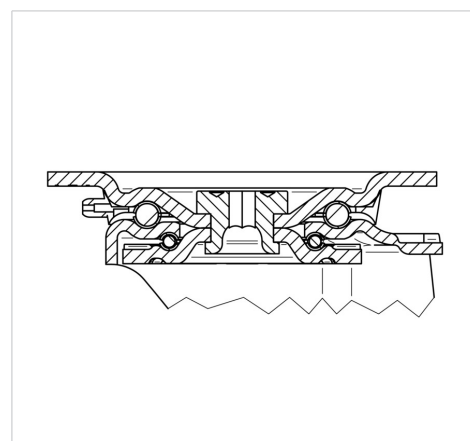

ZETA

4681ITP160P63 Flat

EAN 4031582307986



BETTER MOBILITY. BETTER LIFE.

Structure & Mounting

