

# ZETA

4687IEP125P63

EAN 4031582308112

Swivel caster with total lock, trailing end of caster, housing made of very heavy pressed steel, reinforced, bright zinc plated, blue passivated, sealed swivel double ball bearing, reinforced and heat-treated ball covers, riveted king pin, wheel axle with nut and dust ring with integrated grease nipple., plate fitting. Wheel center made of Aluminum, Tread: black elastic-tire, vulcanized, precision ball bearing



BETTER MOBILITY. BETTER LIFE.



Picture may differ from original product

## Technical Data

Wheel diameter	125 mm
Wheel width	50 mm
Caster width	96 mm
Plate size	137 x 105 mm
Plate hole centers	105 x 80/75 mm
Plate hole	11 mm
Dome-Ø	96 mm
Offset	60 mm
Swivel Interference	322 mm
Overall height	164 mm
Temperature	- 20 / + 85 °C
Standard	EN 12532
Weight	3.175 kg
Swivel Radius	161 mm
Hardness of tread	Shore A 67
Load capacity (dynamic)	300 kg
Load capacity (static)	600 kg

## Advantages at a glance

Roll performance	● ● ● ○ ○
Movement noise	● ● ● ○ ○
Attrition	● ● ● ○ ○
Corrosion resistance	● ● ● ○ ○

## Dimensions

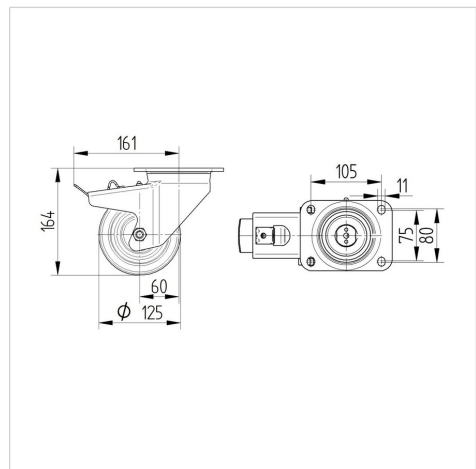

## Structure & Mounting

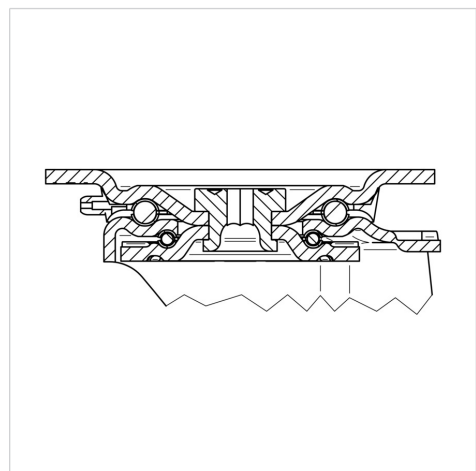

# ZETA

4687IEP125P63

EAN 4031582308112



BETTER MOBILITY. BETTER LIFE.

## Structure & Mounting

