

ZETA

4687UOP250P63

EAN 4031582308242

Swivel caster with total lock, trailing end of caster, housing made of very heavy pressed steel, reinforced, bright zinc plated, blue passivated, sealed swivel double ball bearing, reinforced and heat-treated ball covers, riveted king pin, wheel axle with nut and dust ring with integrated grease nipple., plate fitting. Wheel center made of Polyamide, precision ball bearing



BETTER MOBILITY. BETTER LIFE.



Picture may differ from original product

Technical Data

Wheel diameter	250 mm
Wheel width	50 mm
Caster width	96 mm
Plate size	137 x 105 mm
Plate hole centers	105 x 80/75 mm
Plate hole	11 mm
Dome-Ø	96 mm
Offset	55 mm
Swivel Interference	360 mm
Overall height	290 mm
Temperature	- 30 / + 80 °C
Standard	EN 12532
Weight	3.96 kg
Swivel Radius	180 mm
Hardness of tread	Shore D 75
Load capacity (dynamic)	800 kg
Load capacity (static)	1600 kg

Advantages at a glance

Roll performance	● ● ● ● ●
Movement noise	● ○ ○ ○ ○
Attrition	● ● ● ● ●
Corrosion resistance	● ● ● ○ ○

Dimensions

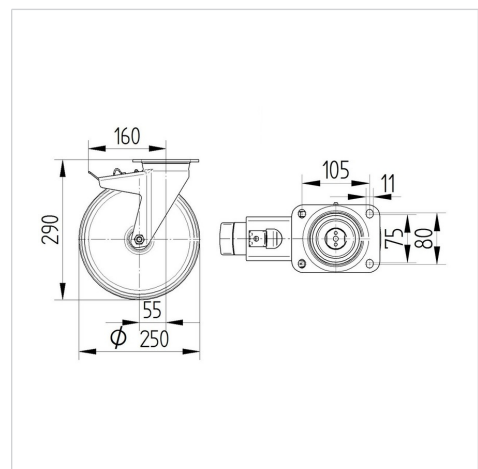

Structure & Mounting

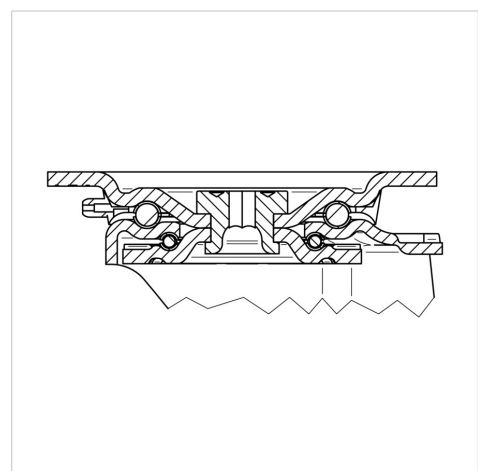

ZETA

4687UOP250P63

EAN 4031582308242



BETTER MOBILITY. BETTER LIFE.

Structure & Mounting

