

ZETA

4688IEP125P63

EAN 4031582308259

Faste hjul, Gaffel af kraftig presset stålplade, forstærket, gul-kromatiseret, hjul boltet i gaffel, befæstigelsesplade.

Hjulfælg: Aluminium, Hjulbane: Elastisk sort gummi, vulkaniseret, DIN-kugleleje



BETTER MOBILITY. BETTER LIFE.



Illustrationen kan afvige fra originalen

Tekniske data

Hjul-Ø	125 mm
Hjulbredde	50 mm
Hjulbredde	117 mm
Plademål	137 x 117 mm
Hulafstand	105 x 80/75 mm
Pladehul-Ø	11 mm
Byggehøjde	164 mm
Temperaturinterval	- 20 / + 85 °C
Standard	EN 12532
Vægt	1.87 kg
Hjulbane hårdhed	Shore A 67
Belastning (dynamisk)	300 kg
Belastning (statisk)	600 kg

Dimensioner

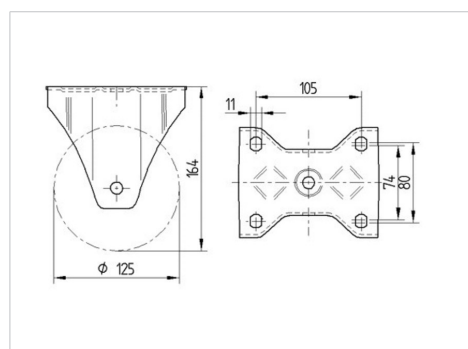

Egenskaber/fordele

Rullemodstand	● ● ● ○ ○
Kørselsstøj	● ● ● ○ ○
Slid	● ● ● ○ ○
Rustbeskyttelse	● ● ● ○ ○

ZETA

4688IEP125P63

EAN 4031582308259



BETTER MOBILITY. BETTER LIFE.

Struktur og montering

