

# ZETA

4688IEP125P63

EAN 4031582308259

Fixed castor, Fork made of heavy pressed steel, reinforced, bright zinc plated, blue passivated, wheel axle with nut, plate fitting.  
Wheel centre made of Aluminium, Tread: black elastic-tyre, vulcanized, precision ball bearing



BETTER MOBILITY. BETTER LIFE.



Picture may differ from original product

## Technical Data

Wheel diameter	125 mm
Wheel width	50 mm
Castor width	117 mm
Size of Plate	137 x 117 mm
Plate hole centres	105 x 80/75 mm
Plate hole	11 mm
Overall height	164 mm
Temperature	- 20 / + 85 °C
Standard	EN 12532
Weight	1.87 kg
Hardness of tread	Shore A 67
Load capacity	300 kg
Load capacity (static)	600 kg

## Dimensions

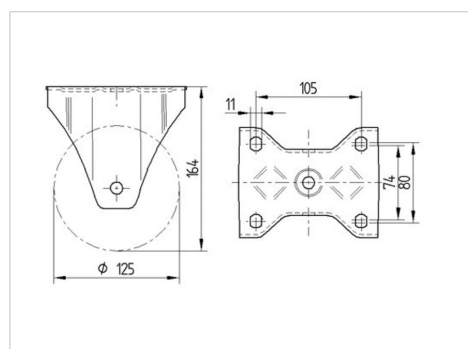

## Advantages at a glance

Roll performance	● ● ● ○ ○
Movement noise	● ● ● ○ ○
Attrition	● ● ● ○ ○
Corrosion resistance	● ● ● ○ ○

# ZETA

4688IEP125P63

EAN 4031582308259



BETTER MOBILITY. BETTER LIFE.

## Structure & Mounting

