

ZETA

4688ITP200P63 Flat

EAN 4031582030525

Faste hjul, Gaffel af kraftig presset stålplade, forstærket, gul-kromatiseret, hjul boltet i gaffel, befæstigelsesplade.

Hjulfælg: Aluminium, Hjulbane: Polyuretan, DIN-kugleleje



BETTER MOBILITY. BETTER LIFE.



Illustrationen kan afvige fra originalen

Tekniske data

Hjul-Ø	200 mm
Hjulbredde	50 mm
Hjulbredde	117 mm
Plademål	137 x 117 mm
Hulafstand	105 x 80/75 mm
Pladehul-Ø	11 mm
Byggehøjde	240 mm
Temperaturinterval	- 10 / + 60 °C
Standard	EN 12532
Vægt	2.644 kg
Hjulbane hårdhed	Shore D 42
Belastning (dynamisk)	800 kg
Belastning (statisk)	1600 kg

Dimensioner

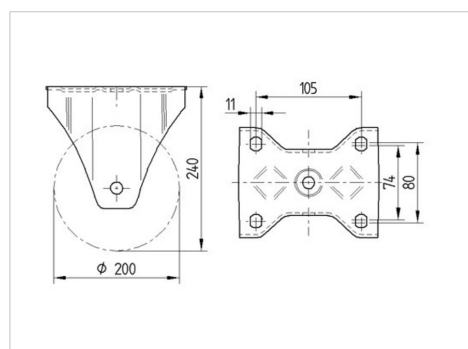

Egenskaber/fordele

Rullemodstand	● ● ● ○ ○
Kørselsstøj	● ● ● ○ ○
Slid	● ● ● ● ○
Rustbeskyttelse	● ● ● ○ ○

ZETA

4688ITP200P63 Flat

EAN 4031582030525



BETTER MOBILITY. BETTER LIFE.

Struktur og montering

