

ZETA

4688ITP200P63 Flat

EAN 4031582030525

Fixed caster, Fork made of heavy pressed steel, reinforced, bright zinc plated, blue passivated, wheel axle with nut, plate fitting.
Wheel center made of Aluminum, Tread: Polyurethane, casted, precision ball bearing



BETTER MOBILITY. BETTER LIFE.



Picture may differ from original product

Technical Data

Wheel diameter	200 mm
Wheel width	50 mm
Caster width	117 mm
Plate size	137 x 117 mm
Plate hole centers	105 x 80/75 mm
Plate hole	11 mm
Overall height	240 mm
Temperature	- 10 / + 60 °C
Standard	EN 12532
Weight	2.644 kg
Hardness of tread	Shore D 42
Load capacity (dynamic)	800 kg
Load capacity (static)	1600 kg

Dimensions

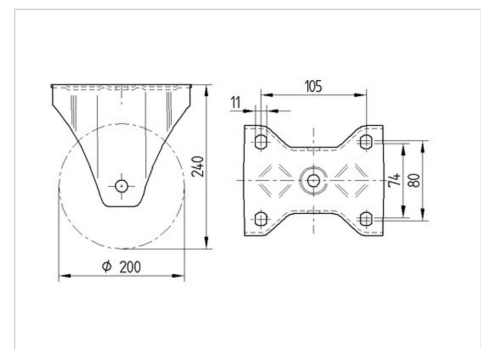

Advantages at a glance

Roll performance	● ● ● ○ ○
Movement noise	● ● ● ○ ○
Attrition	● ● ● ○ ○
Corrosion resistance	● ● ● ○ ○

ZETA

4688ITP200P63 Flat

EAN 4031582030525



BETTER MOBILITY. BETTER LIFE.

Structure & Mounting

