

ZETA

4688UOP200P63

EAN 4031582308372

Fiksirani točkić, Viljuska napravljena od jako presovanog celika, ojacana, zuto pocinkovana, osovina tocka sa maticom, Priključak ploca..
Telo tocka od poliamida , precizni kuglicni lezaj

TENTE

BETTER MOBILITY. BETTER LIFE.



Picture may differ from original product

Tehnicki podaci

Precnik tocka.	200 mm
Sirina gazista.	50 mm
Sirina tocka	117 mm
Dimenzije ploce.	137 x 117 mm
Raspored rupa na ploci.	105 x 80/75 mm
Rupa na ploci.	11 mm
Sveukupna visina.	240 mm
Temperatura	- 30 / + 80 °C
Standard	EN 12532
Tezina	2.144 kg
Tvrdoca omotaca	Shore D 75
Dinamicka nosivost.	800 kg
Staticka nosivost.	1600 kg

Dimensions

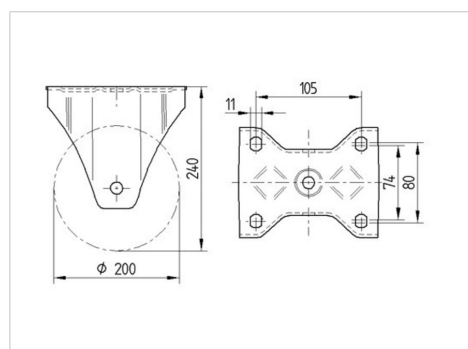

Advantages at a glance

Otpor okretanju	● ● ● ● ●
Buka pri okretanju	● ○ ○ ○ ○
trenje , habanje	● ● ● ● ●
zastita od korozije	● ● ● ○ ○

ZETA

4688UOP200P63

EAN 4031582308372



BETTER MOBILITY. BETTER LIFE.

Structure & Mounting

