

ALPHA

8470UFX200P63

EAN 4031582312652

Swivel castor, Housing made of Stainless Steel, double ball bearing swivel head, wheel axle with nut, plate fitting. Wheel centre made of Polyamide, Tread: elastic-tyre, non-marking, with small threadguards, precision ball bearing, sealed



BETTER MOBILITY. BETTER LIFE.



Picture may differ from original product

Technical Data

Wheel diameter	200 mm
Wheel width	46 mm
Castor width	96 mm
Size of Plate	137 x 105 mm
Plate hole centres	105 x 80/75 mm
Plate hole	11 mm
Dome-Ø	96 mm
Offset	55 mm
Swivel Interference	310 mm
Overall height	240 mm
Temperature	- 20 / + 80 °C
Standard	EN 12532
Weight	2.659 kg
Swivel Radius	155 mm
Hardness of tread	Shore A 63
Load capacity	400 kg
Load capacity (static)	800 kg

Advantages at a glance

Roll performance	● ● ● ○ ○
Movement noise	● ● ● ● ●
Attrition	● ● ● ○ ○
Corrosion resistance	● ● ● ● ●

Dimensions

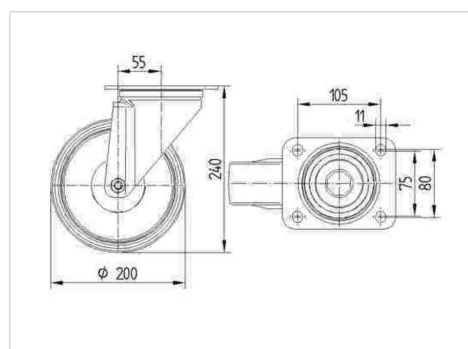

Structure & Mounting

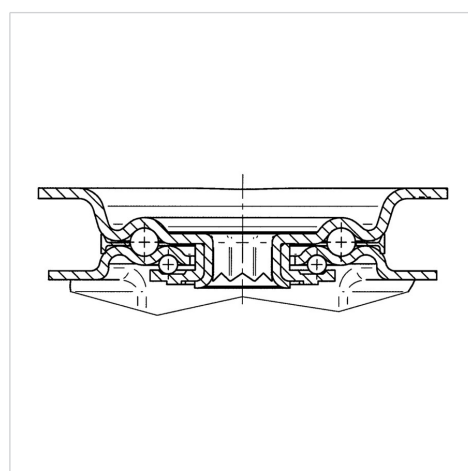

ALPHA

8470UFX200P63

EAN 4031582312652



BETTER MOBILITY. BETTER LIFE.

Structure & Mounting

