

ALPHA

8477UFX125P30-13

EAN 4031582313024

Swivel caster with total lock, trailing end of caster, housing made of Stainless Steel, double ball bearing swivel head, wheel axle with nut, bolt hole. Wheel center made of Polyamide, Tread: elastic-tire, non-marking, with small threadguards, precision ball bearing, sealed



BETTER MOBILITY. BETTER LIFE.



Picture may differ from original product

Technical Data

Wheel diameter	125 mm
Wheel width	40 mm
Caster width	75 mm
Center hole	13 mm
Dome-Ø	75 mm
Offset	40 mm
Swivel Interference	246 mm
Overall height	155 mm
Temperature	- 20 / + 80 °C
Standard	EN 12532
Weight	1.13 kg
Swivel Radius	123 mm
Hardness of tread	Shore A 63
Load capacity (dynamic)	200 kg
Load capacity (static)	400 kg

Dimensions

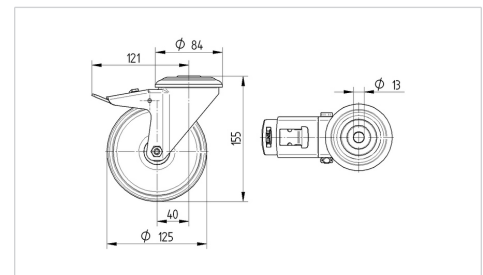

Structure & Mounting

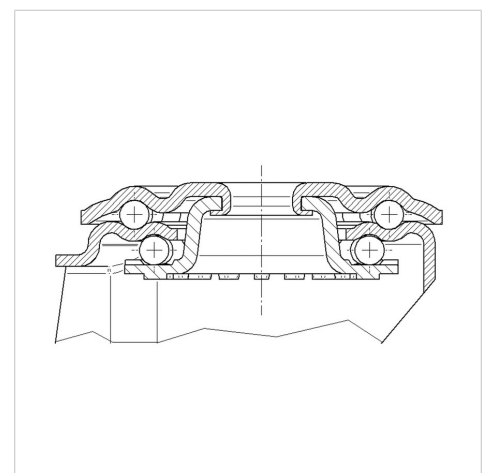

Advantages at a glance

Roll performance	● ● ● ○ ○
Movement noise	● ● ● ● ●
Attrition	● ● ● ○ ○
Corrosion resistance	● ● ● ● ●