

ALPHA

8478U00080P62

EAN 4031582313383

Fixed caster, Fork made of Stainless Steel, wheel axle with nut, plate fitting.

Wheel center made of Polyamide, plain bearing



BETTER MOBILITY. BETTER LIFE.



Picture may differ from original product

Technical Data

Wheel diameter	80 mm
Wheel width	34 mm
Caster width	85 mm
Plate size	100 x 85 mm
Plate hole centers	80/77 x 60 mm
Plate hole	9 mm
Overall height	108 mm
Temperature	- 40 / + 80 °C
Standard	EN 12532
Weight	0.376 kg
Hardness of tread	Shore D 75
Load capacity (dynamic)	200 kg
Load capacity (static)	400 kg

Dimensions

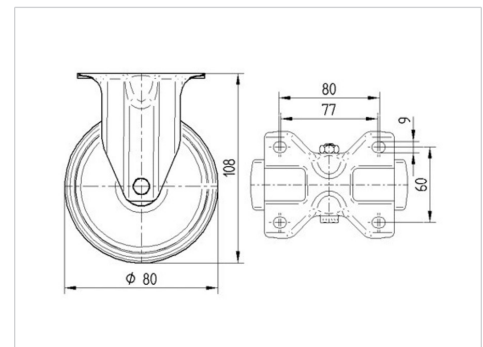

Advantages at a glance

Roll performance	● ● ● ○ ○
Movement noise	● ● ● ○ ○
Attrition	● ● ● ● ●
Corrosion resistance	● ● ● ● ●

ALPHA

8478U00080P62

EAN 4031582313383



BETTER MOBILITY. BETTER LIFE.

Structure & Mounting

