

OMIKRON

9250FTP300P65

EAN 4031582314007

Swivel caster, housing and plate steel-welded, zinc plated, blue passivated, sealed swivel bearing with dual purpose bearing and tapered roller bearing, threaded king pin and locking nut secured, grease nipple, wheel axle with nut, plate fitting. Wheel center made of cast iron, Tread: Polyurethane, casted, precision ball bearing



BETTER MOBILITY. BETTER LIFE.



Picture may differ from original product

Technical Data

Wheel diameter	300 mm
Wheel width	100 mm
Plate size	200 x 160 mm
Plate hole centers	160 x 120 mm
Plate hole	15 mm
Offset	90 mm
Swivel Interference	480 mm
Overall height	370 mm
Temperature	- 20 / + 60 °C
Standard	EN 12533
Weight	38.205 kg
Swivel Radius	240 mm
Hardness of tread	Shore A 92
Load capacity (dynamic)	2600 kg
Load capacity (static)	5200 kg

Advantages at a glance

Roll performance	● ● ● ● ○
Movement noise	● ● ● ○ ○
Attrition	● ● ● ● ○
Corrosion resistance	● ● ● ○ ○

Dimensions

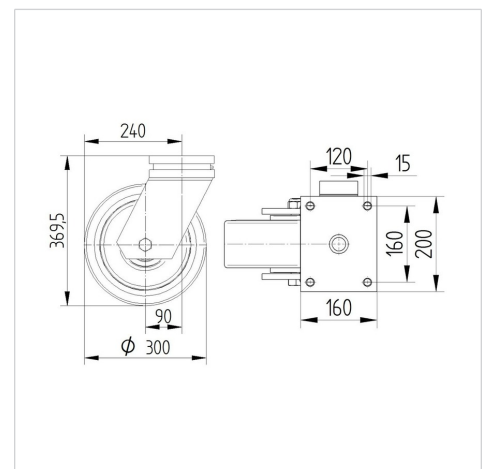

Structure & Mounting

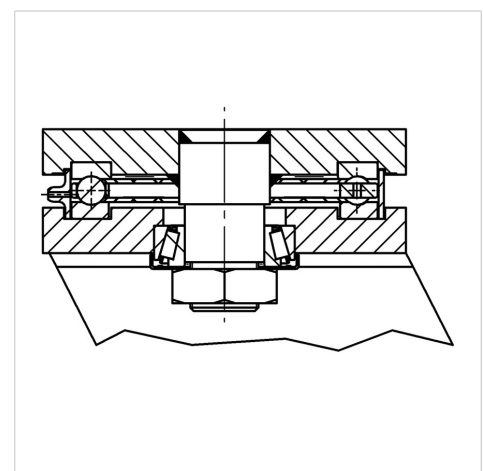

OMIKRON

9250FTP300P65

EAN 4031582314007



BETTER MOBILITY. BETTER LIFE.

Structure & Mounting

