

OMIKRON

9258FTP400P66

EAN 4031582314106

Fixed castor, Fork and plate steel welded, zinc plated, blue passivated, wheel axle with nut, plate fitting.

Wheel centre made of cast iron, Tread: Polyurethane, casted, precision ball bearing



BETTER MOBILITY. BETTER LIFE.



Picture may differ from original product

Technical Data

Wheel diameter	400 mm
Wheel width	100 mm
Castor width	182 mm
Size of Plate	250 x 200 mm
Plate hole centres	210 x 160 mm
Plate hole	17 mm
Dome-Ø	160 mm
Overall height	470 mm
Temperature	- 10 / + 60 °C
Standard	EN 12533
Weight	41.154 kg
Hardness of tread	Shore D 42
Load capacity	3840 kg
Load capacity (static)	7680 kg

Dimensions

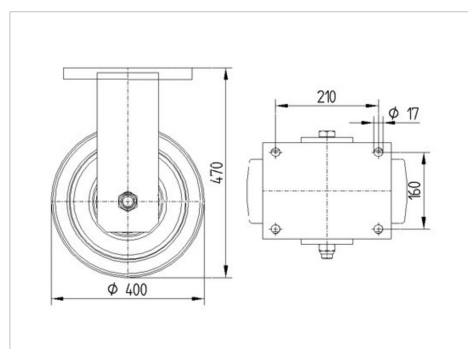

Advantages at a glance

Roll performance	● ● ● ● ○
Movement noise	● ● ● ○ ○
Attrition	● ● ● ● ○
Corrosion resistance	● ● ● ○ ○

OMIKRON

9258FTP400P66

EAN 4031582314106



BETTER MOBILITY. BETTER LIFE.

Structure & Mounting

