

OMIKRON

9258FTP400P66

EAN 4031582314106

Fiksirani točkić, Viljuska i ploca zavareni, pocinkovani, osovina tocka sa caurom, Priključak ploca..

Telo tocka napravljeno od livenog gvozdja, Omotac: poliuretan, precizni kuglicni lezaj

TENTE

BETTER MOBILITY. BETTER LIFE.



Picture may differ from original product

Tehnicki podaci

| | |
|-------------------------|----------------|
| Precnik tocka. | 400 mm |
| Sirina gazista. | 100 mm |
| Sirina tocka | 182 mm |
| Dimenzije ploce. | 250 x 200 mm |
| Raspored rupa na ploci. | 210 x 160 mm |
| Rupa na ploci. | 17 mm |
| Kupola -Ø | 160 mm |
| Sveukupna visina. | 470 mm |
| Temperatura | - 10 / + 60 °C |
| Standard | EN 12533 |
| Tezina | 41.154 kg |
| Tvrdoca omotaca | Shore D 42 |
| Dinamicka nosivost. | 3840 kg |
| Staticka nosivost. | 7680 kg |

Dimensions

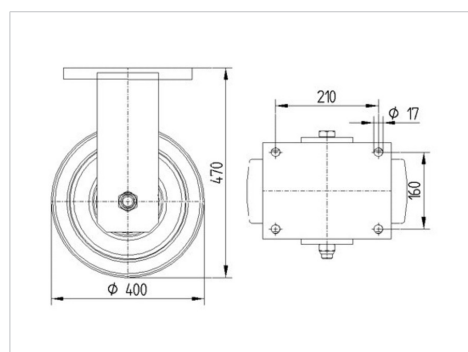

Advantages at a glance

| | |
|---------------------|-----------|
| Otpor okretanju | ● ● ● ● ○ |
| Buka pri okretanju | ● ● ● ○ ○ |
| trenje , habanje | ● ● ● ● ○ |
| zastita od korozije | ● ● ● ○ ○ |

OMIKRON

9258FTP400P66

EAN 4031582314106



BETTER MOBILITY. BETTER LIFE.

Structure & Mounting

