

OMIKRON

9258STP300P66

EAN 4031582314137

Fixed caster, Fork and plate steel welded, zinc plated, blue passivated, wheel axle with nut, plate fitting.

Wheel center made of pressed steel, lacquered, heavy duty, Tread: Polyurethane, casted, precision ball bearing



BETTER MOBILITY. BETTER LIFE.



Picture may differ from original product

Technical Data

Wheel diameter	300 mm
Wheel width	100 mm
Plate size	250 x 200 mm
Plate hole centers	210 x 160 mm
Plate hole	17 mm
Overall height	370 mm
Temperature	- 20 / + 60 °C
Standard	EN 12533
Weight	33.807 kg
Hardness of tread	Shore A 92
Load capacity (dynamic)	2600 kg
Load capacity (static)	5200 kg

Dimensions

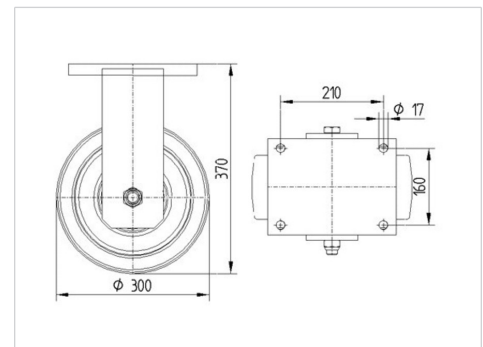

Advantages at a glance

Roll performance	● ● ● ○ ○
Movement noise	● ● ● ○ ○
Attrition	● ● ● ● ○
Corrosion resistance	● ● ● ○ ○

OMIKRON

9258STP300P66

EAN 4031582314137



BETTER MOBILITY. BETTER LIFE.

Structure & Mounting

