

OMIKRON

9258STP300P66

EAN 4031582314137

Fiksirani točkić, Viljuska i ploca zavareni, pocinkovani, osovina tocka sa caurom, Priključak ploca..

Telo tocka od presovanog celika, lakirano , visoke nosivosti Omotac: Poliuretan, liven, precizni kuglicni lezaj

TENTE

BETTER MOBILITY. BETTER LIFE.



Picture may differ from original product

Tehnicki podaci

Precnik tocka.	300 mm
Sirina gazista.	100 mm
Dimenzije ploce.	250 x 200 mm
Raspored rupa na ploci.	210 x 160 mm
Rupa na ploci.	17 mm
Sveukupna visina.	370 mm
Temperatura	- 20 / + 60 °C
Standard	EN 12533
Tezina	33.807 kg
Tvrdoća omotaca	Shore A 92
Dinamička nosivost.	2600 kg
Statička nosivost.	5200 kg

Dimensions

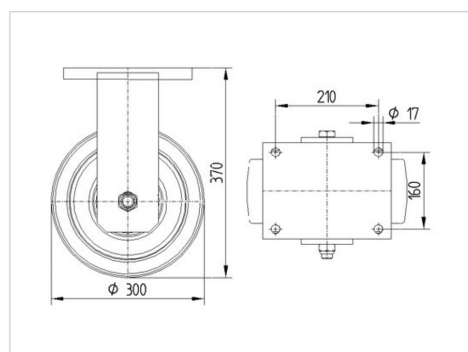

Advantages at a glance

Otpor okretanju	● ● ● ○ ○
Buka pri okretanju	● ● ● ○ ○
trenje , habanje	● ● ● ● ○
zastita od korozije	● ● ● ○ ○

OMIKRON

9258STP300P66

EAN 4031582314137



BETTER MOBILITY. BETTER LIFE.

Structure & Mounting

