

OMIKRON

9258STP400P66

EAN 4031582314144

Fixed castor, Fork and plate steel welded, zinc plated, blue passivated, wheel axle with nut, plate fitting.

Wheel centre made of pressed steel, lacquered, heavy duty, Tread: Polyurethane, casted, precision ball bearing



BETTER MOBILITY. BETTER LIFE.



Picture may differ from original product

Technical Data

Wheel diameter	400 mm
Wheel width	100 mm
Size of Plate	250 x 200 mm
Plate hole centres	210 x 160 mm
Plate hole	17 mm
Overall height	470 mm
Temperature	- 20 / + 60 °C
Standard	EN 12533
Weight	46.95 kg
Hardness of tread	Shore A 92
Load capacity	3200 kg
Load capacity (static)	6400 kg

Dimensions

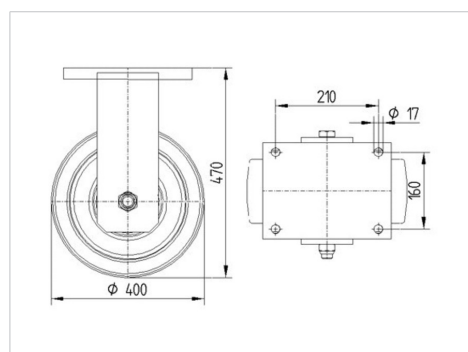

Advantages at a glance

Roll performance	● ● ● ○ ○
Movement noise	● ● ● ○ ○
Attrition	● ● ● ● ○
Corrosion resistance	● ● ● ○ ○

OMIKRON

9258STP400P66

EAN 4031582314144



BETTER MOBILITY. BETTER LIFE.

Structure & Mounting

