

KAPPA

9650FTP150P63 WT50

EAN 4031582314151

Swivel caster, housing and plate steel-welded, bright zinc plated, blue passivated, sealed swivel bearing with dual purpose bearing and tapered roller bearing, threaded king pin and locking nut secured, grease nipple, wheel axle with nut, plate fitting. Wheel center made of cast iron, Tread: Polyurethane, casted, precision ball bearing



BETTER MOBILITY. BETTER LIFE.



Picture may differ from original product

Technical Data

Wheel diameter	150 mm
Wheel width	50 mm
Caster width	110 mm
Plate size	135 x 110 mm
Plate hole centers	105 x 80/75 mm
Plate hole	11 mm
Dome-Ø	111 mm
Offset	58 mm
Swivel Interference	275 mm
Overall height	200 mm
Temperature	- 10 / + 60 °C
Standard	EN 12533
Weight	6.7 kg
Swivel Radius	137.5 mm
Hardness of tread	Shore D 42
Load capacity (dynamic)	800 kg
Load capacity (static)	1600 kg

Dimensions

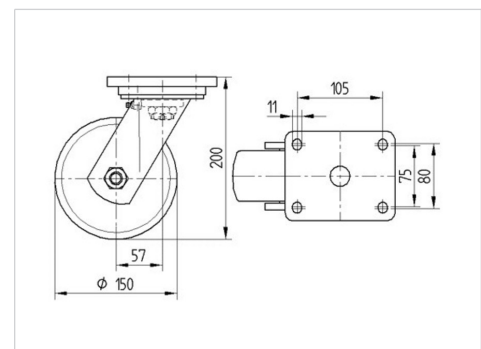

Structure & Mounting

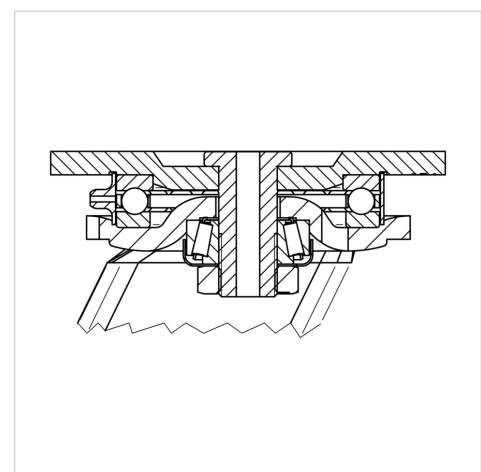

Advantages at a glance

Roll performance	● ● ● ● ○
Movement noise	● ● ● ○ ○
Attrition	● ● ● ● ○
Corrosion resistance	● ● ● ○ ○

KAPPA

9650FTP150P63 WT50

EAN 4031582314151



BETTER MOBILITY. BETTER LIFE.

Structure & Mounting

