

KAPPA

9651FTP200P64

EAN 4031582314489

okretan tocak sa usmerenom kocnicom, Kuciste i ploca su zavareni, pocinkovani, zapezaceni okretni lezajevi sa duplom svrhom i valjkastim lezajem, lozovan klin ,mazalica i osovina tocka sa maticom, Prikljucak ploca.. Telo tocka napravljeno od livenog gvozdja, Omotac: poliuretan, precizni kuglicni lezaj

TENTE

BETTER MOBILITY. BETTER LIFE.



Picture may differ from original product

Tehnicki podaci

Precnik tocka.	200 mm
Sirina gazista.	80 mm
Sirina tocka	140 mm
Dimenzije ploce.	175 x 140 mm
Raspored rupa na ploci.	140 x 105 mm
Rupa na ploci.	15 mm
Kupola -Ø	140 mm
Dislokacija	65 mm
Otpor okretanju.	340 mm
Sveukupna visina.	255 mm
Temperatura	- 10 / + 60 °C
Standard	EN 12533
Tezina	13.376 kg
Radius okretanja	170 mm
Tvrdoca omotaca	Shore D 42
Dinamicka nosivost.	1400 kg
Staticka nosivost.	2800 kg

Advantages at a glance

Otpor okretanju	● ● ● ● ○
Buka pri okretanju	● ● ● ○ ○
trenje , habanje	● ● ● ● ○
zastita od korozije	● ● ● ○ ○

Dimensions

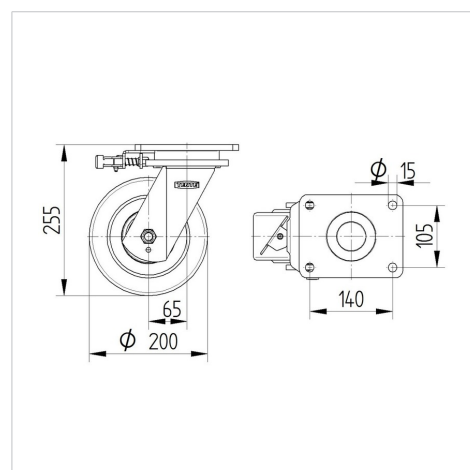

Structure & Mounting



KAPPA

9651FTP200P64

EAN 4031582314489



BETTER MOBILITY. BETTER LIFE.

Structure & Mounting

