

KAPPA

9658FTP300P64

EAN 4031582316346

Fixed caster, Fork and plate steel welded, bright zinc plated, blue passivated, wheel axle with nut, plate fitting.
Wheel center made of cast iron, Tread: Polyurethane, casted, precision ball bearing



BETTER MOBILITY. BETTER LIFE.



Picture may differ from original product

Technical Data

Wheel diameter	300 mm
Wheel width	80 mm
Plate size	175 x 140 mm
Plate hole centers	140 x 105 mm
Plate hole	15 mm
Overall height	355 mm
Temperature	- 20 / + 60 °C
Standard	EN 12533
Weight	17.229 kg
Hardness of tread	Shore A 92
Load capacity (dynamic)	2000 kg
Load capacity (static)	4000 kg

Dimensions

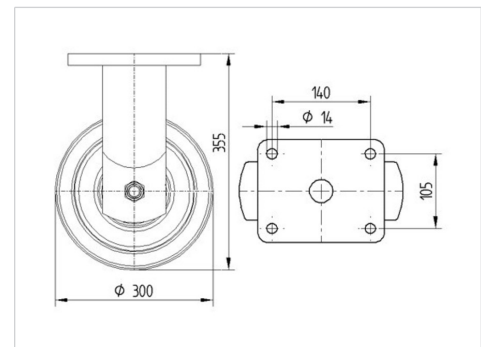

Advantages at a glance

Roll performance	● ● ● ● ○
Movement noise	● ● ● ○ ○
Attrition	● ● ● ● ○
Corrosion resistance	● ● ● ○ ○

KAPPA

9658FTP300P64

EAN 4031582316346



BETTER MOBILITY. BETTER LIFE.

Structure & Mounting

