

KAPPA

9680FTP150P63 WT60

EAN 4031582315004

Swivel castor, housing and plate steel-welded, bright zinc plated, blue passivated, sealed single swivel double ball bearing, threaded king pin and locking nut secured, grease nipple, wheel axle with nut, plate fitting. Wheel centre made of cast iron, Tread: Polyurethane, casted, precision ball bearing



BETTER MOBILITY. BETTER LIFE.



Picture may differ from original product

Technical Data

Wheel diameter	150 mm
Wheel width	60 mm
Castor width	110 mm
Size of Plate	135 x 110 mm
Plate hole centres	105 x 80/75 mm
Plate hole	11 mm
Dome-Ø	111 mm
Offset	58 mm
Swivel Interference	275 mm
Overall height	200 mm
Temperature	- 10 / + 60 °C
Standard	EN 12533
Weight	6.313 kg
Swivel Radius	137.5 mm
Hardness of tread	Shore D 42
Load capacity	800 kg
Load capacity (static)	1600 kg

Advantages at a glance

Roll performance	● ● ● ● ○
Movement noise	● ● ● ○ ○
Attrition	● ● ● ● ○
Corrosion resistance	● ● ● ○ ○

Dimensions

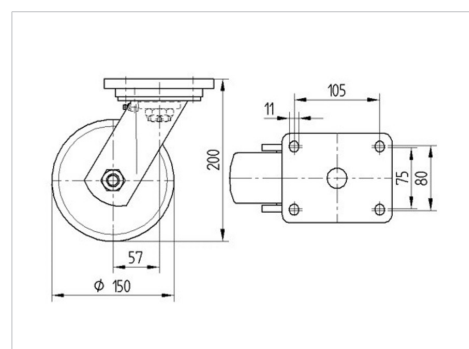

Structure & Mounting

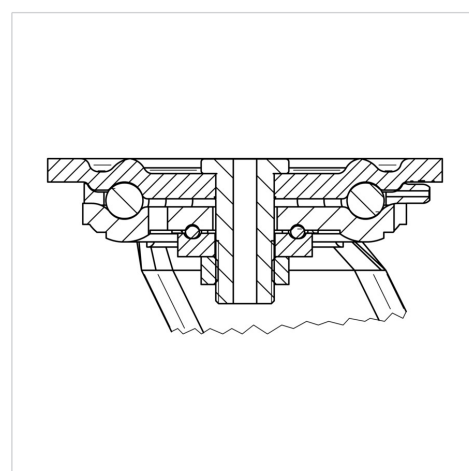

KAPPA

9680FTP150P63 WT60

EAN 4031582315004



BETTER MOBILITY. BETTER LIFE.

Structure & Mounting

