

KAPPA

9680ITP200P63 Flat

EAN 4031582315219

Obrtni točkić, Kuciste i ploca su zavareni, pocinkovani, zapečaceni dupli okretni kuglični lezajevi ,lozovan klin ,mazalica i osovina tocka sa maticom, Priključak ploca.. Telo tocka od aluminijuma, Omotac: Poliuretan , liven, precizni kuglični lezaj

TENTE

BETTER MOBILITY. BETTER LIFE.



Picture may differ from original product

Tehnicki podaci

Precnik tocka.	200 mm
Sirina gazista.	50 mm
Sirina tocka	110 mm
Dimenzije ploce.	135 x 110 mm
Raspored rupa na ploci.	105 x 80/75 mm
Rupa na ploci.	11 mm
Kupola -Ø	111 mm
Dislokacija	59 mm
Otpor okretanju.	320 mm
Sveukupna visina.	245 mm
Temperatura	- 10 / + 60 °C
Standard	EN 12532
Tezina	4.505 kg
Radius okretanja	160 mm
Tvrdoca omotaca	Shore D 42
Dinamicka nosivost.	800 kg
Staticka nosivost.	1600 kg

Advantages at a glance

Otpor okretanju	● ● ● ○ ○
Buka pri okretanju	● ● ● ○ ○
trenje , habanje	● ● ● ● ○
zastita od korozije	● ● ● ○ ○

Dimensions

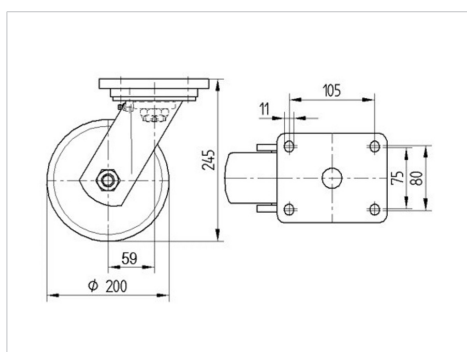

Structure & Mounting

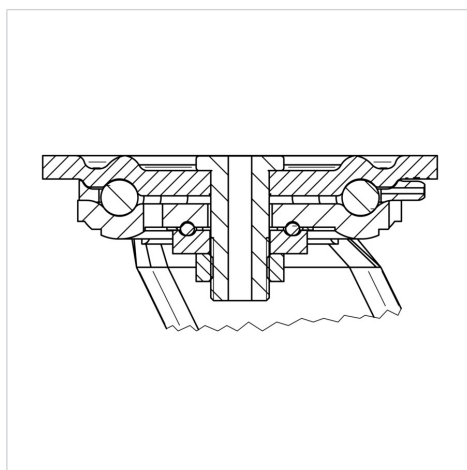

KAPPA

9680ITP200P63 Flat

EAN 4031582315219



BETTER MOBILITY. BETTER LIFE.

Structure & Mounting

