

KAPPA

9680TOO100P63

EAN 4031582315233

Obrtni točkić, Kuciste i ploca su zavareni, pocinkovani, zapečaceni dupli okretni kuglični lezajevi ,lozovan klin ,mazalica i osovina tocka sa maticom, Priključak ploca.. Telo tocka od poliamida, visoke nosivosti, obican lezaj

TENTE

BETTER MOBILITY. BETTER LIFE.



Picture may differ from original product

Tehnicki podaci

Precnik tocka.	100 mm
Sirina gazista.	50 mm
Sirina tocka	110 mm
Dimenzije ploce.	135 x 110 mm
Raspored rupa na ploci.	105 x 80/75 mm
Rupa na ploci.	11 mm
Kupola -Ø	111 mm
Dislokacija	41 mm
Otpor okretanju.	190 mm
Sveukupna visina.	145 mm
Temperatura	- 40 / + 80 °C
Standard	EN 12533
Tezina	3.175 kg
Radius okretanja	95 mm
Tvrdoca omotaca	Shore D 75
Dinamicka nosivost.	600 kg
Staticka nosivost.	1200 kg

Advantages at a glance

Otpor okretanju	● ● ● ● ● ○
Buka pri okretanju	● ○ ○ ○ ○ ○
trenje , habanje	● ● ● ● ● ●
zastita od korozije	● ● ● ○ ○

Dimensions

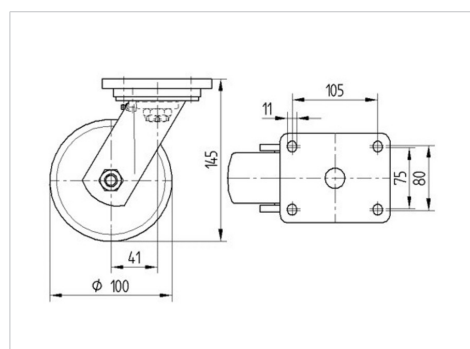

Structure & Mounting

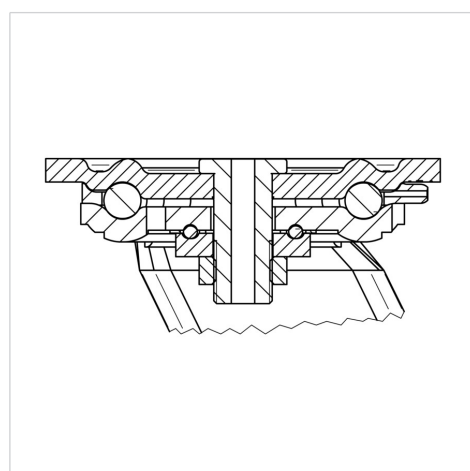

KAPPA

9680TOO100P63

EAN 4031582315233



BETTER MOBILITY. BETTER LIFE.

Structure & Mounting

