

# KAPPA

9680TOO160P63

EAN 4031582315264

Swivel castor, housing and plate steel-welded, bright zinc plated, blue passivated, sealed single swivel double ball bearing, threaded king pin and locking nut secured, grease nipple, wheel axle with nut, plate fitting. Wheel centre made of Polyamide, heavy duty, plain bearing



BETTER MOBILITY. BETTER LIFE.



Picture may differ from original product

## Technical Data

Wheel diameter	160 mm
Wheel width	50 mm
Size of Plate	135 x 110 mm
Plate hole centres	105 x 80/75 mm
Plate hole	11 mm
Offset	58 mm
Swivel Interference	276 mm
Overall height	205 mm
Temperature	- 40 / + 80 °C
Standard	EN 12533
Weight	3.832 kg
Swivel Radius	138 mm
Hardness of tread	Shore D 75
Load capacity	850 kg
Load capacity (static)	1700 kg

## Advantages at a glance

Roll performance	● ● ● ● ○
Movement noise	● ○ ○ ○ ○
Attrition	● ● ● ● ●
Corrosion resistance	● ● ● ○ ○

## Dimensions

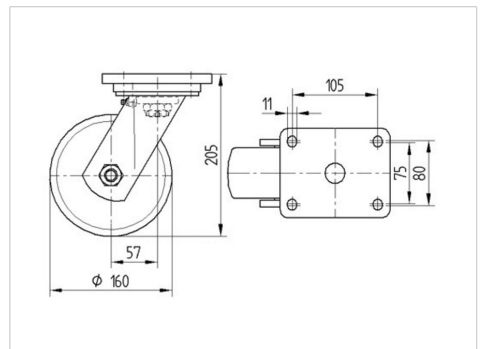

## Structure & Mounting

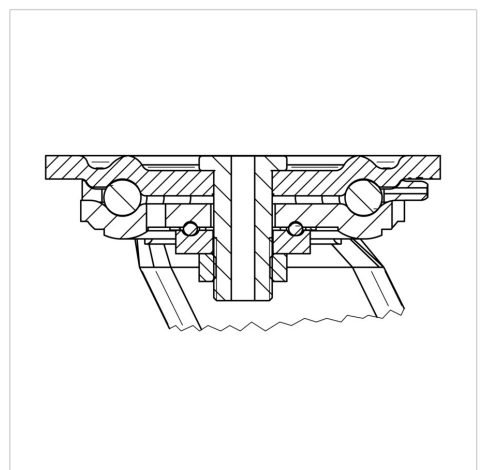

# KAPPA

9680TOO160P63

EAN 4031582315264



BETTER MOBILITY. BETTER LIFE.

## Structure & Mounting

